

FM Graham 0675-CF Series Carrier Frame

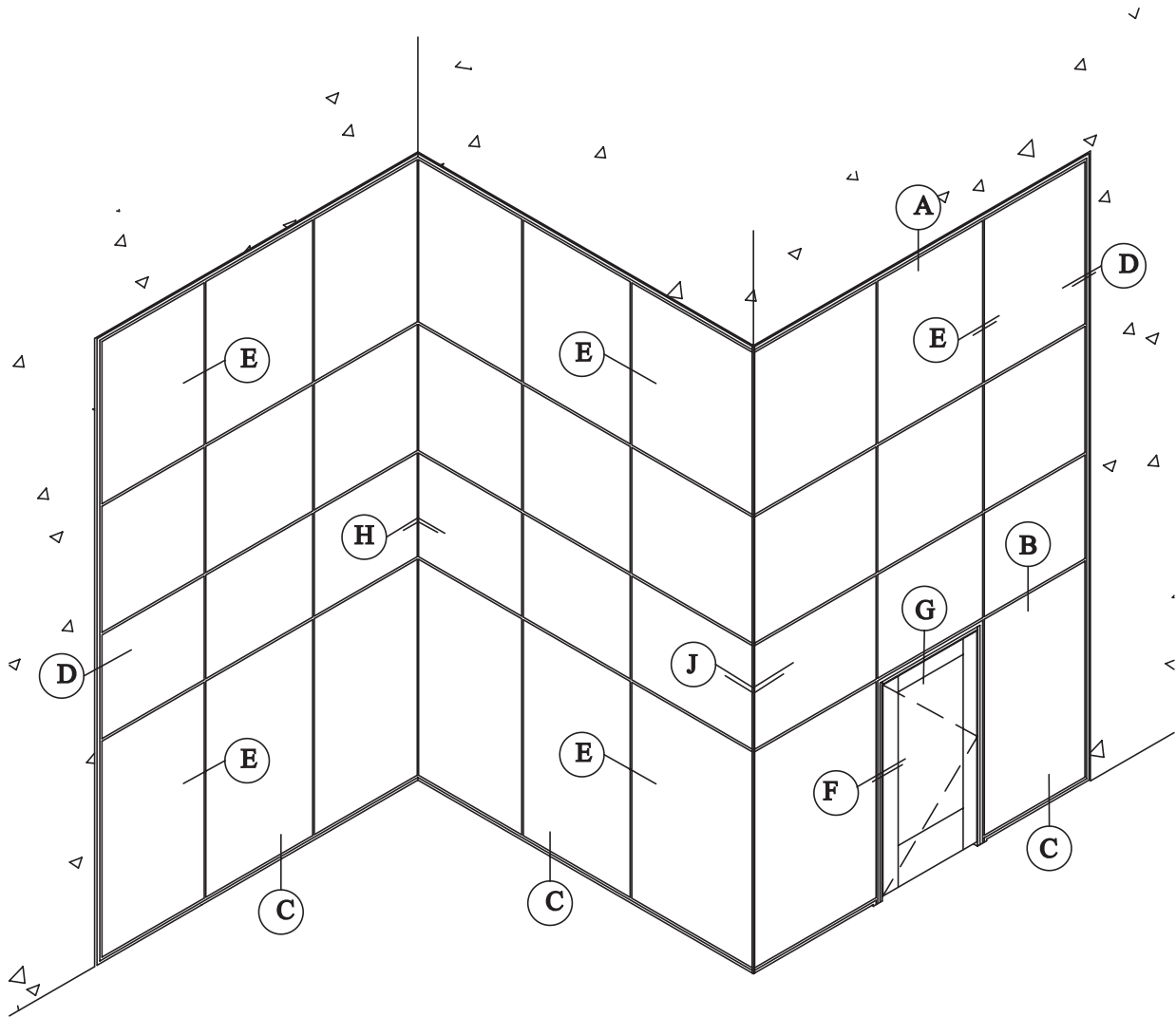

Elevation of Carrier Frame Wall

FM Graham 0675-CF Series Carrier Frame

Go to Elevation View

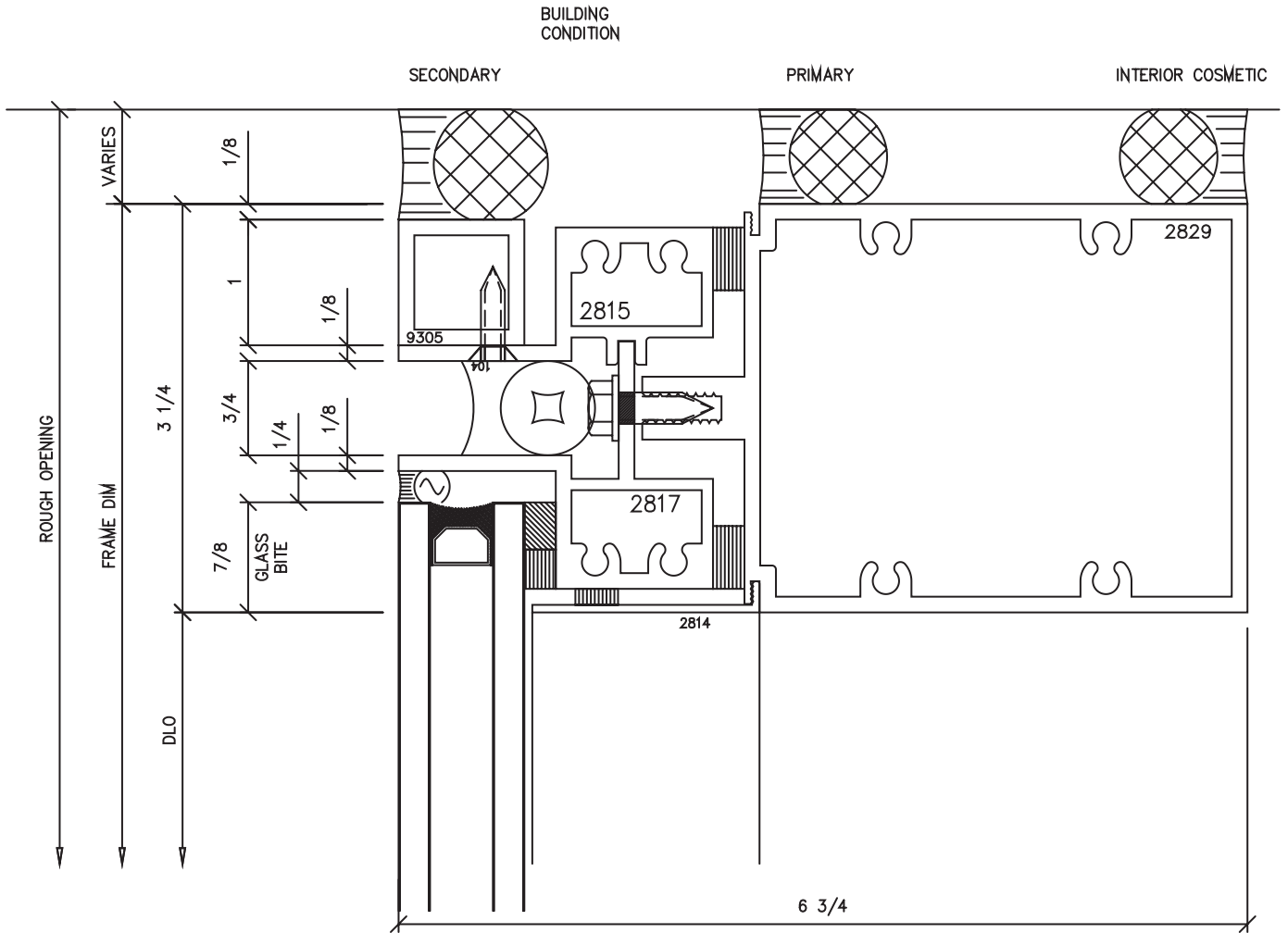

A
Head

FM Graham 0675-CF Series Carrier Frame

Go to Elevation View

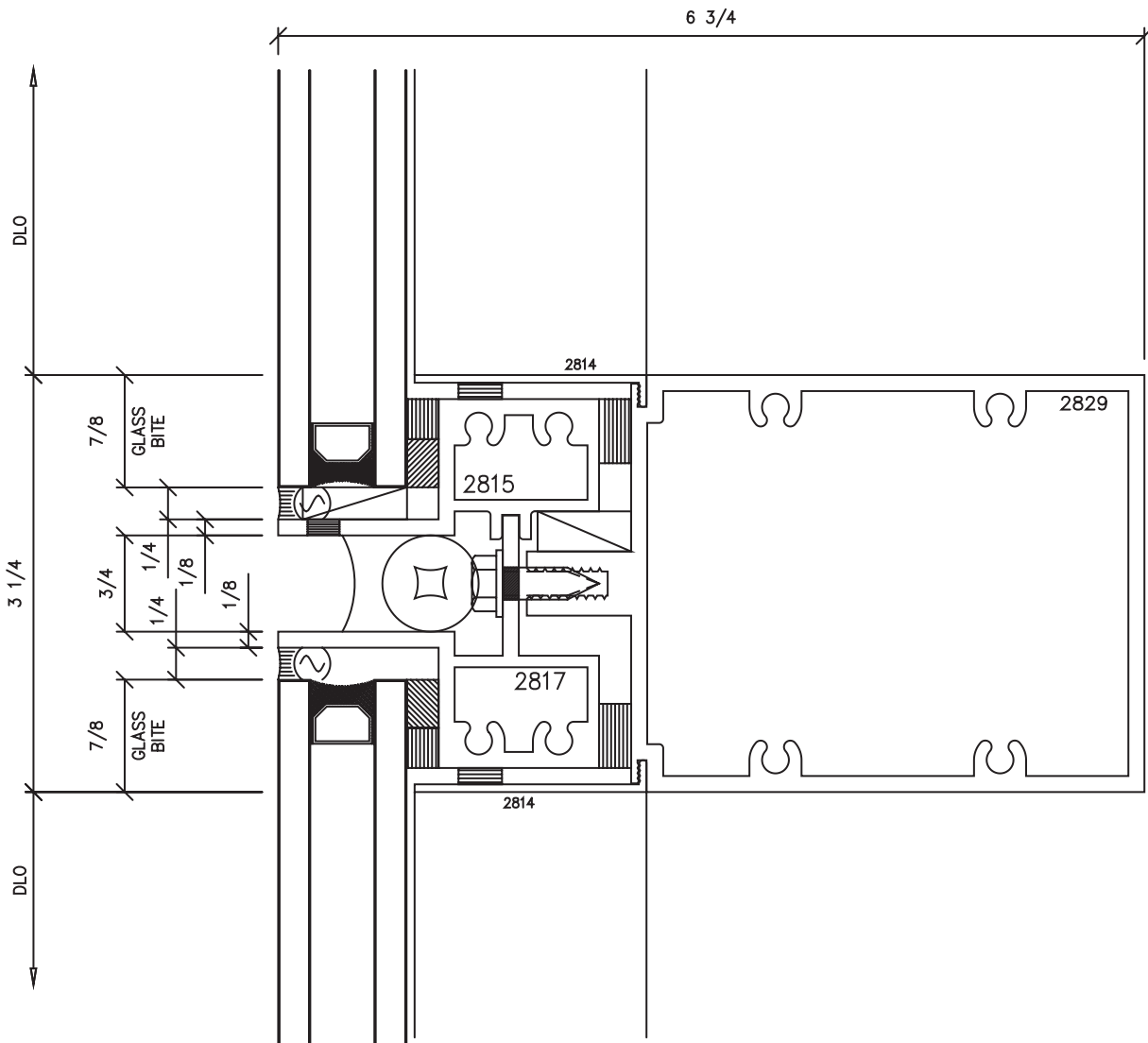

B

Horizontal

FM Graham 0675-CF Series Carrier Frame

Go to Elevation View

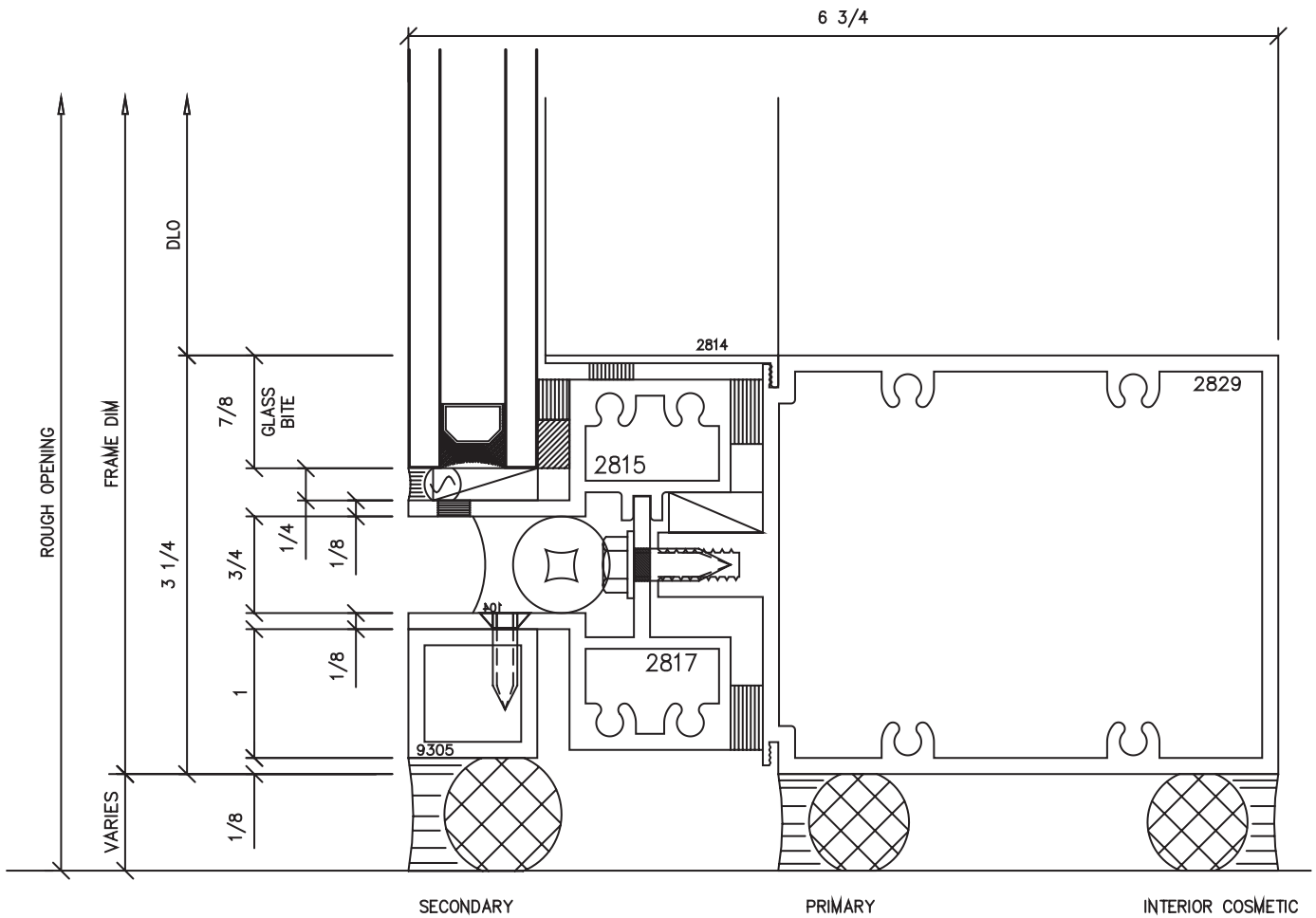

CONDITION
BUILDING

C

Sill

FM Graham 0675-CF Series Carrier Frame

Go to Elevation View

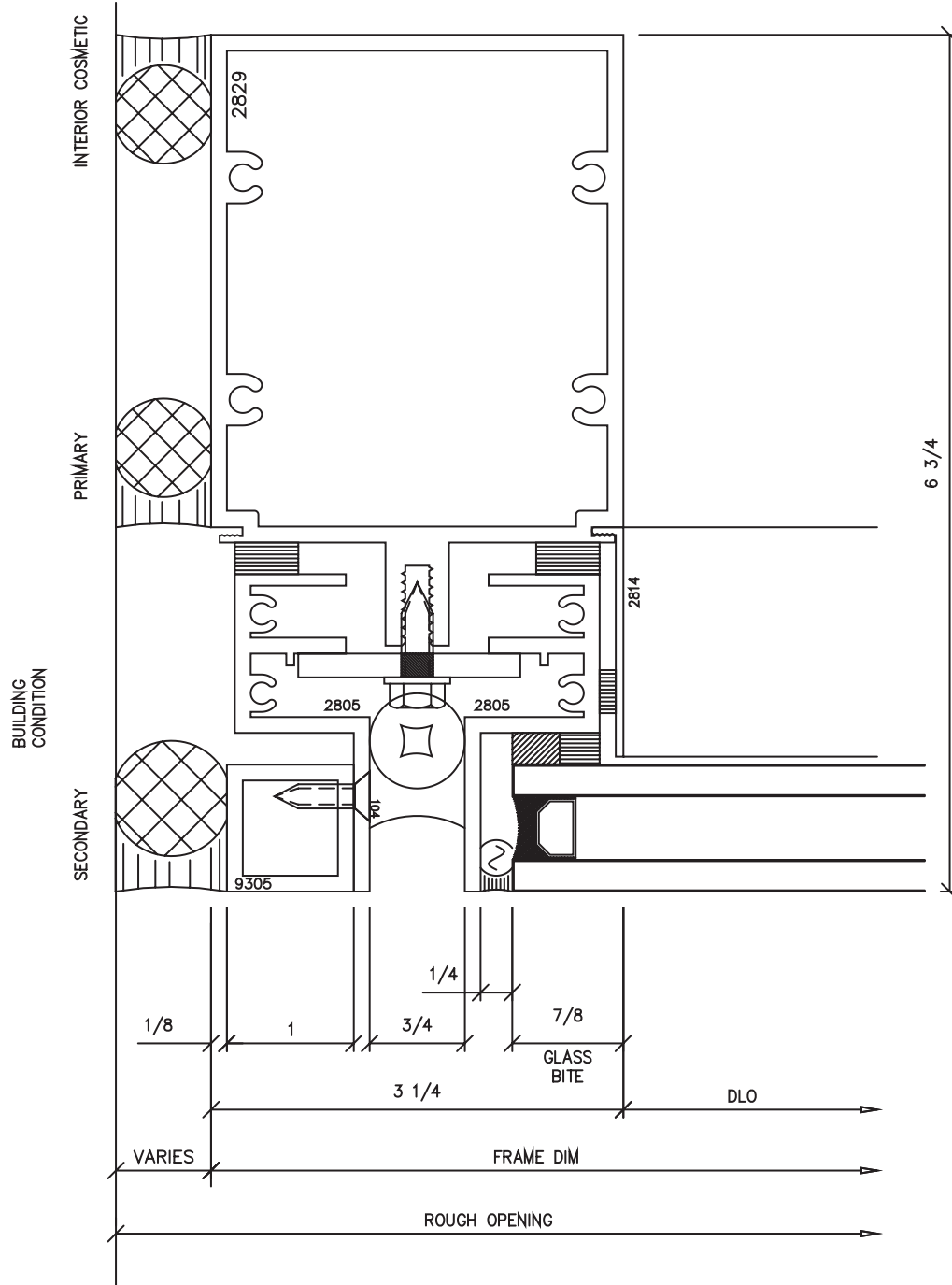

D

Jamb

FM Graham 0675-CF Series Carrier Frame

Go to Elevation View

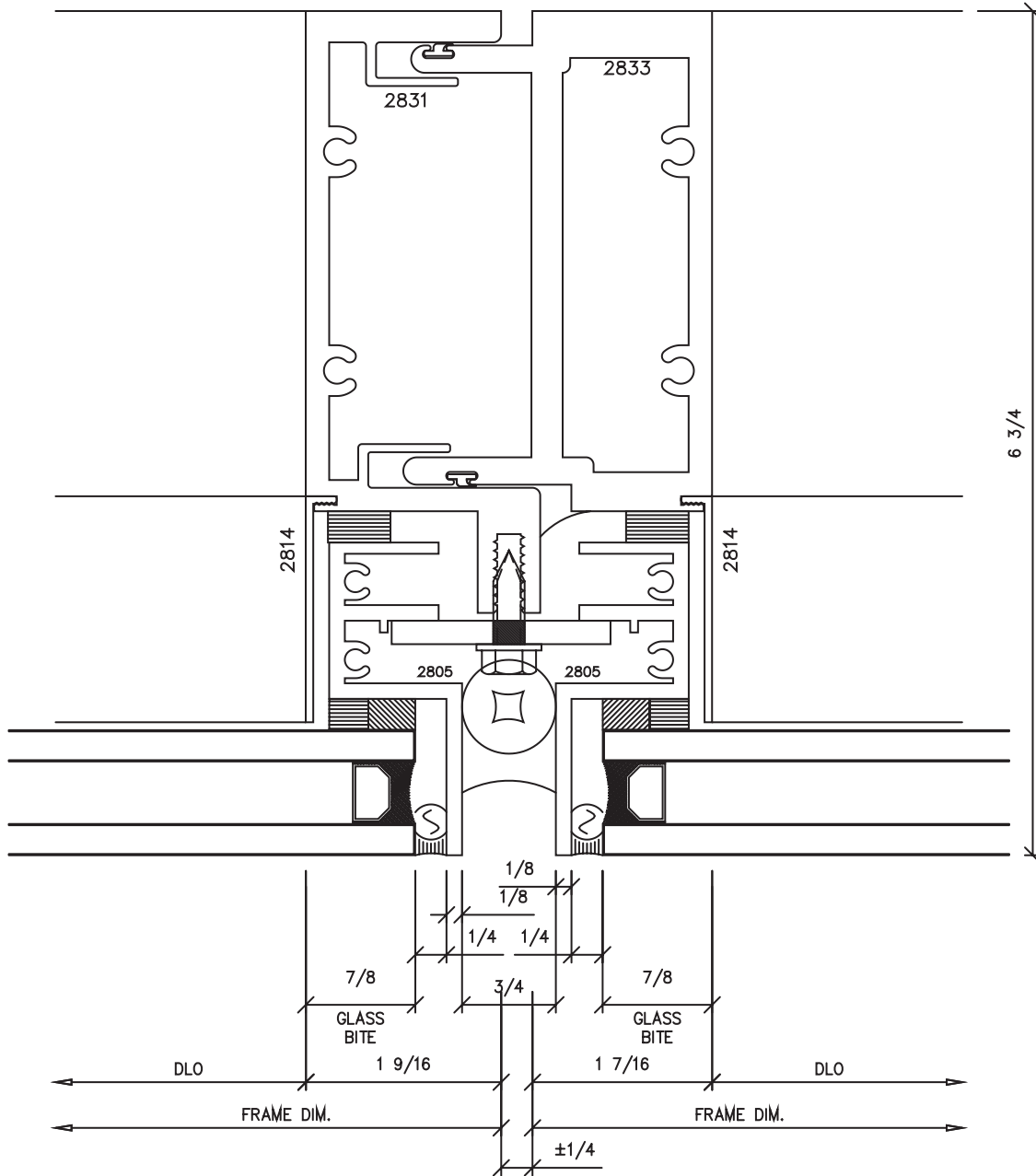

E

Vertical

FM Graham 0675-CF Series Carrier Frame

Go to Elevation View

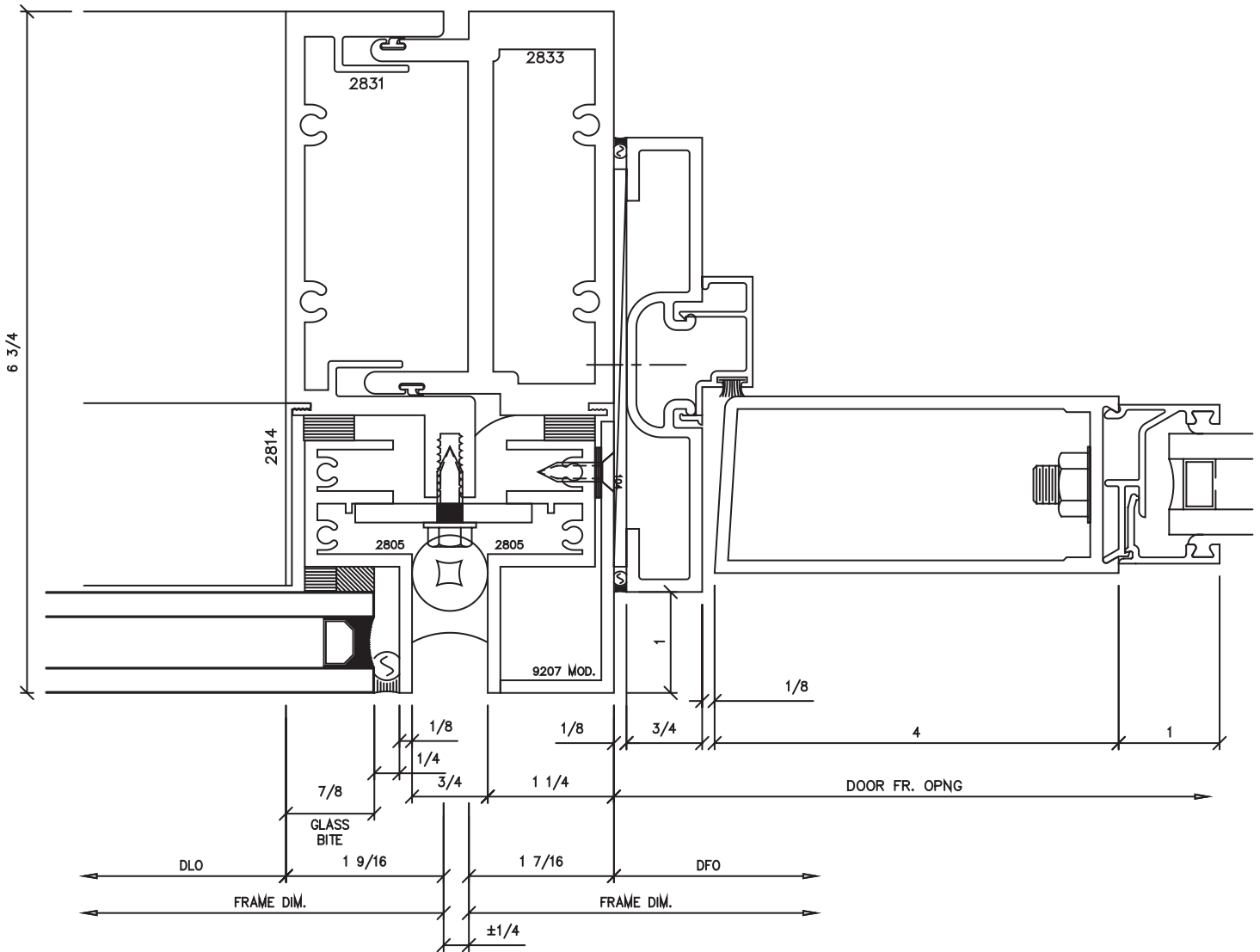

F

Door Jamb

FM Graham 0675-CF Series Carrier Frame

Go to Elevation View

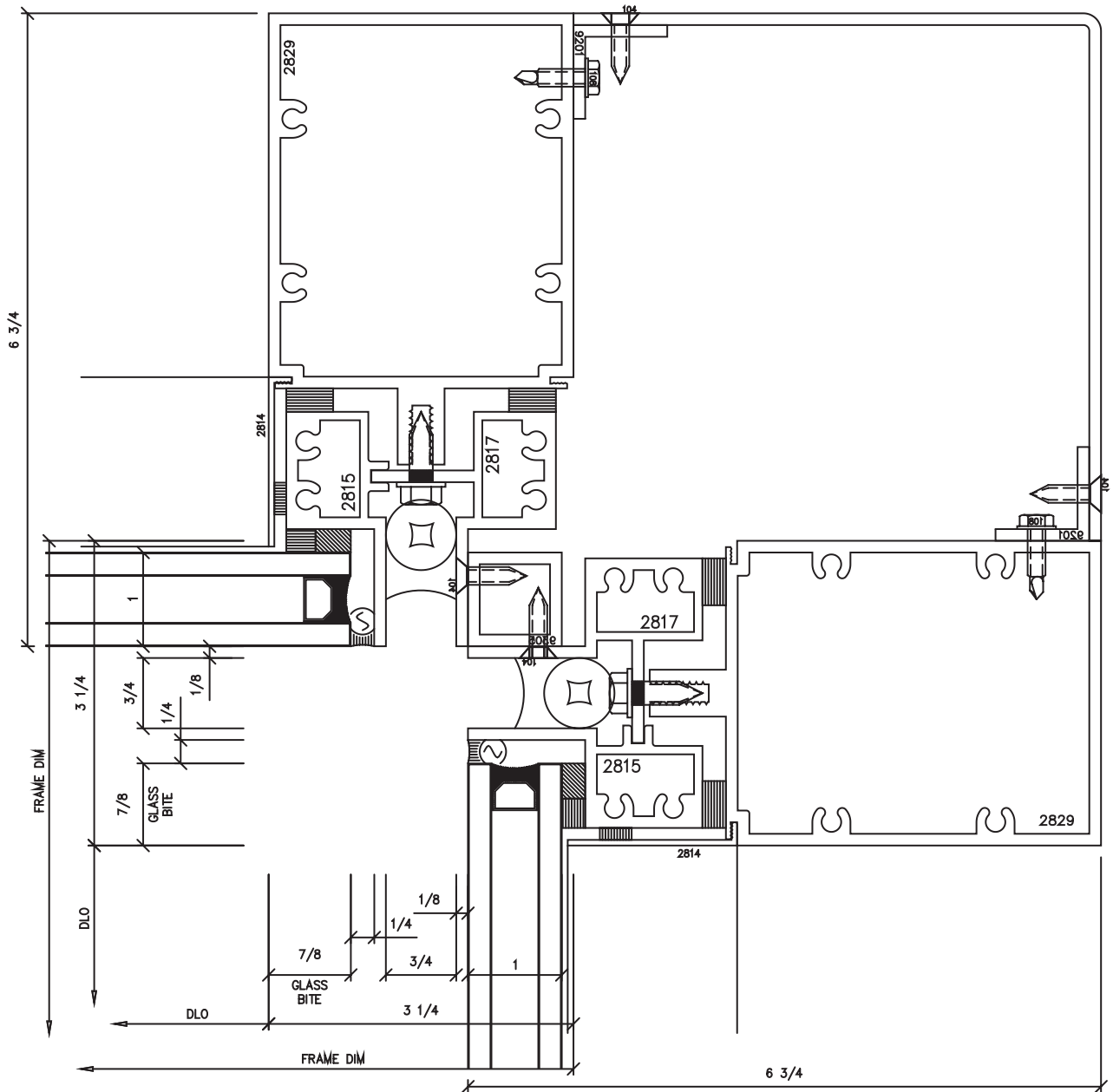

(H)

Inside Corner

FM Graham 0675-CF Series Carrier Frame

Go to Elevation View

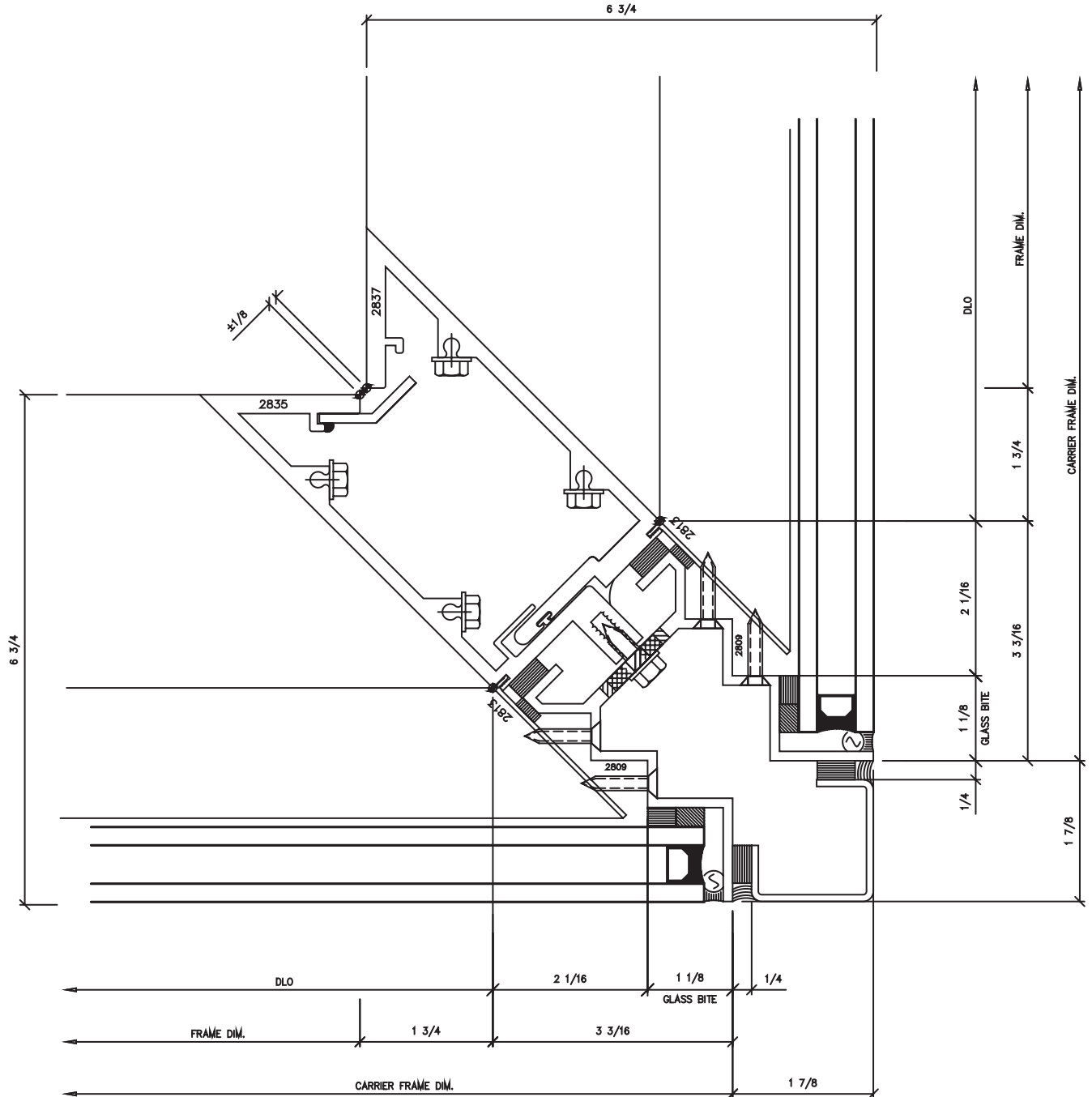

J

Outside Corner