

Frame Options – 3 1/4” Historic



Series: 1200H

Manufacturing Code: 1208

Drawing 1/2 Scale – For Custom Size Drawing Contact Graham

Note: Sealant Not Shown On Details. Refer To General Installation Instructions.

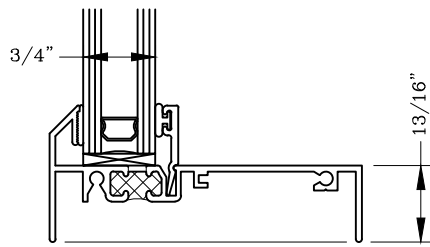

Historic Sill
Equal Leg Frame
#200310

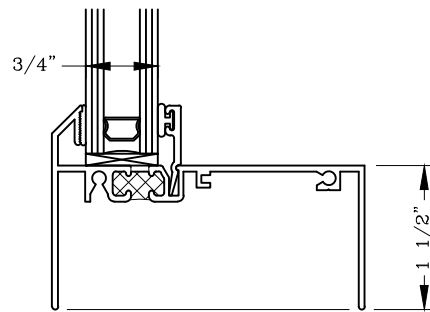

Historic Sill
Extended Leg Frame
#200315

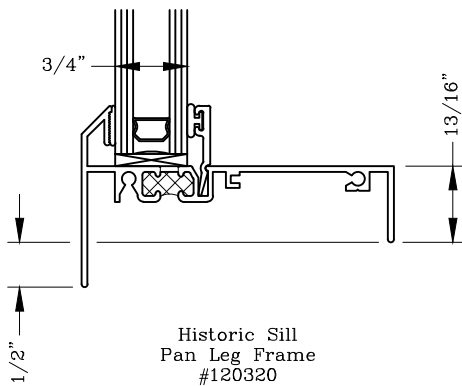

Historic Sill
Pan Leg Frame
#120320

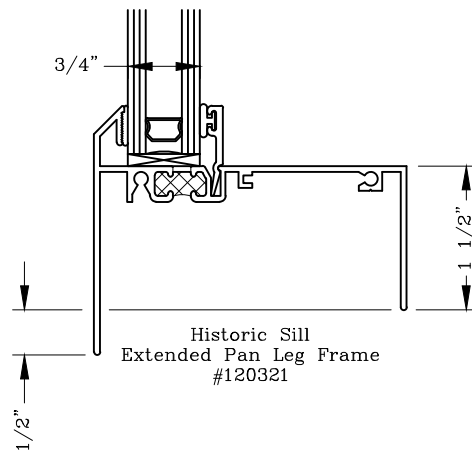

Historic Sill
Extended Pan Leg Frame
#120321

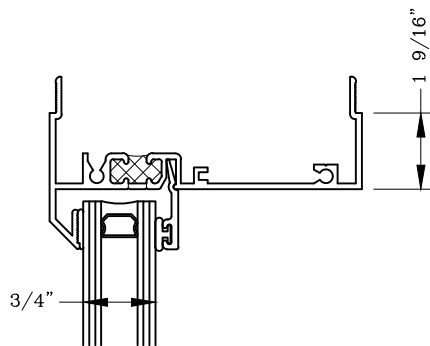

Historic Head
Self-Mull Frame
#200311

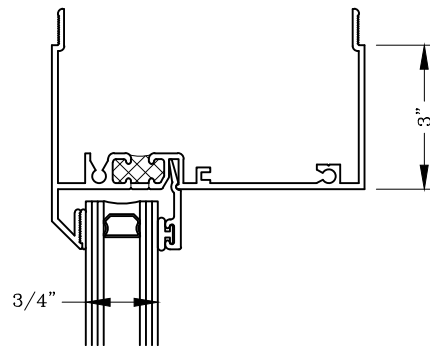

Historic Head
Extended Self-Mull Frame
#200316

Graham Architectural Products reserves the right to change, add, cancel, remove or otherwise modify the details illustrated without prior notice.

1551 Mt. Rose Avenue, York, Pennsylvania 17403-2909 800/755-6274 Fax: 800/366-5097

0922 – 12.08

Web Site: www.grahamwindows.com