

2-1/2" x 6"
Curtain Wall
Series: 2506C



Product Description

Drawing Not To Scale – For Custom Size Drawing Contact Graham

Note: Consult Technical Services At Factory For Sealing Procedures.

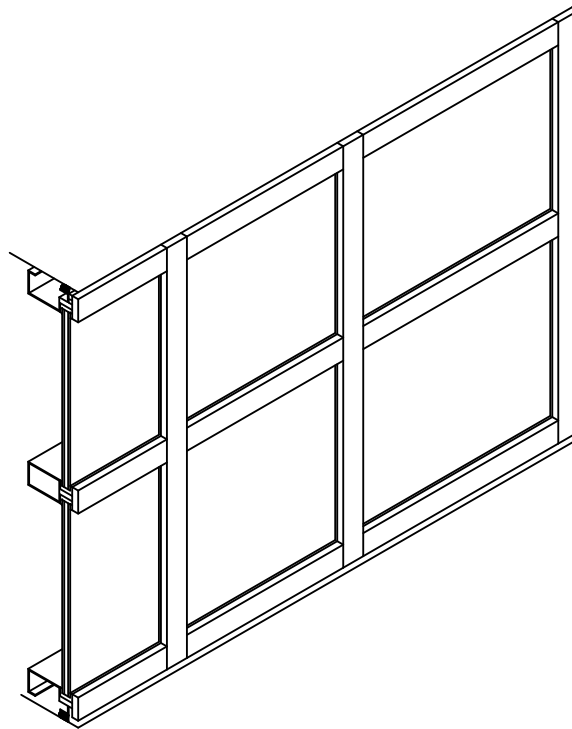

Graham 2506C series curtainwall is an outside glazed captured system designed for low to medium rise structures. It has a face width of 2 1/2" and a depth of 6 1/4". It incorporates a split male-female vertical mullion which allows factory assembly and sealing of the frame.

The 2506C series incorporates 1/4" glazing gaskets and a 3/8" thick thermal isolator. It can accommodate infill material from 1/4" up to 1 1/8" thick. Infill material is secured in with a screw applied pressure plate. A snap-on cover conceals the pressure plate screws and allows the use of different finishes on the interior and exterior exposed metal surfaces.