

Accessories – GT Products 3 3/8"



Series: Accessories Manufacturing Code: GT04A

Drawing 1/2 Scale – For Custom Size Drawing Contact Graham

Note: Sealant Not Shown On Details. Refer To General Installation Instructions.

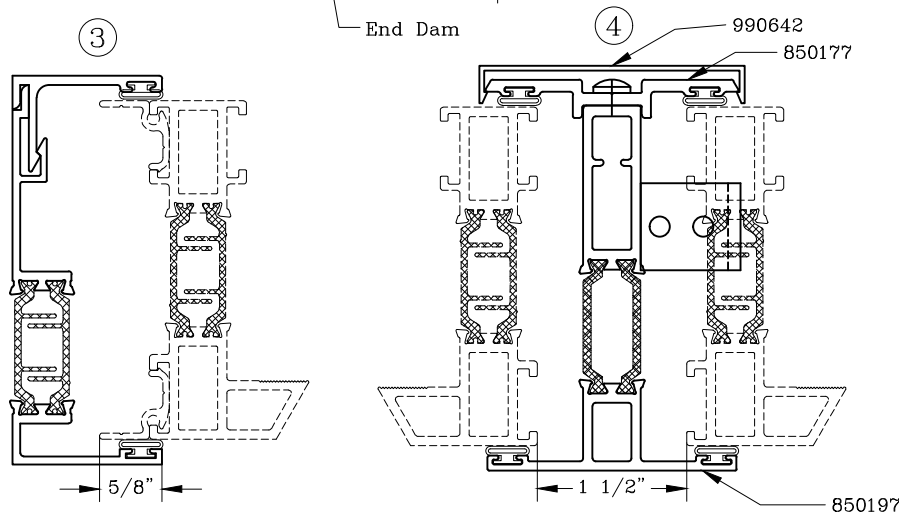
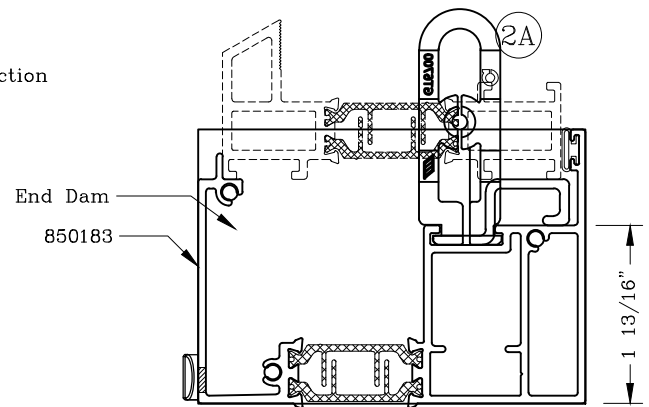
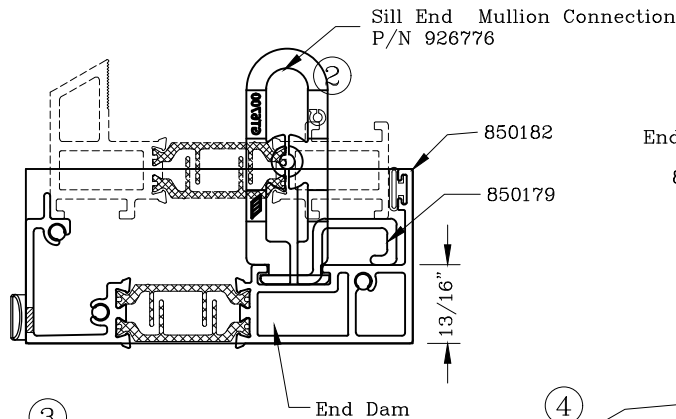
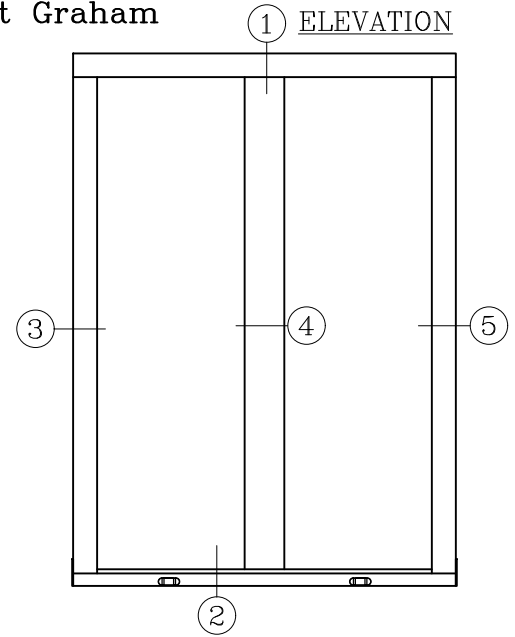
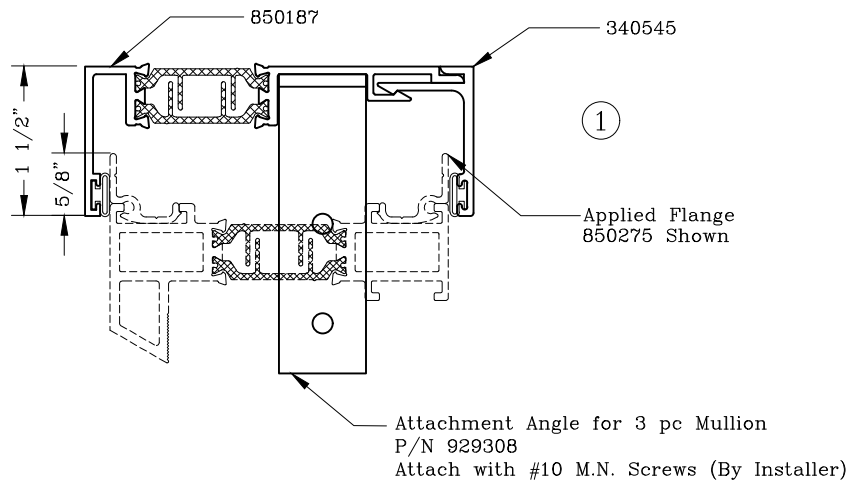

Graham Architectural Products reserves the right to change, add, cancel, remove or otherwise modify the details illustrated without prior notice.

1551 Mt. Rose Avenue, York, Pennsylvania 17403-2909 800/755-6274 Fax: 800/366-5097

1019 – AC.GT04A

Web Site: www.grahamwindows.com