

# Interior Trim Assemblies 1/2" To 1" Clip Face



Series:Accessories Manufacturing Code:TR01A

Drawing 1/2 Scale – For Custom Size Drawing Contact Graham

Note: Sealant Not Shown On Details. Refer To General Installation Instructions.

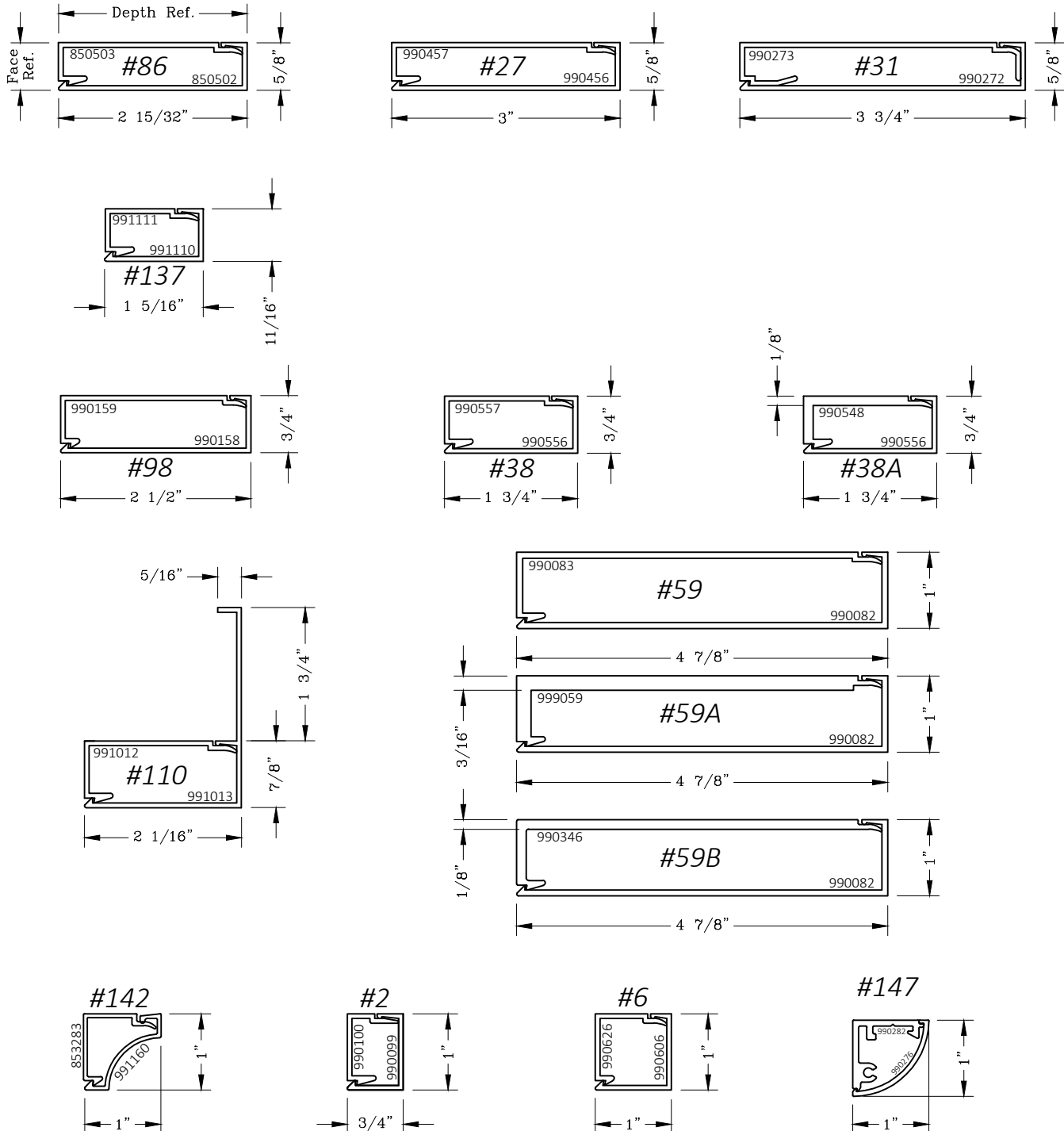

Graham Architectural Products reserves the right to change, add, cancel, remove or otherwise modify the details illustrated without prior notice.

1551 Mt. Rose Avenue, York, Pennsylvania 17403-2909 800/755-6274 Fax: 800/366-5097

Web Site: [www.grahamwindows.com](http://www.grahamwindows.com)

1121 - TR.01A

# Interior Trim Assemblies 1/2" To 1" Clip Face



Series:Accessories Manufacturing Code:TR01B

Drawing 1/2 Scale – For Custom Size Drawing Contact Graham

Note: Sealant Not Shown On Details. Refer To General Installation Instructions.

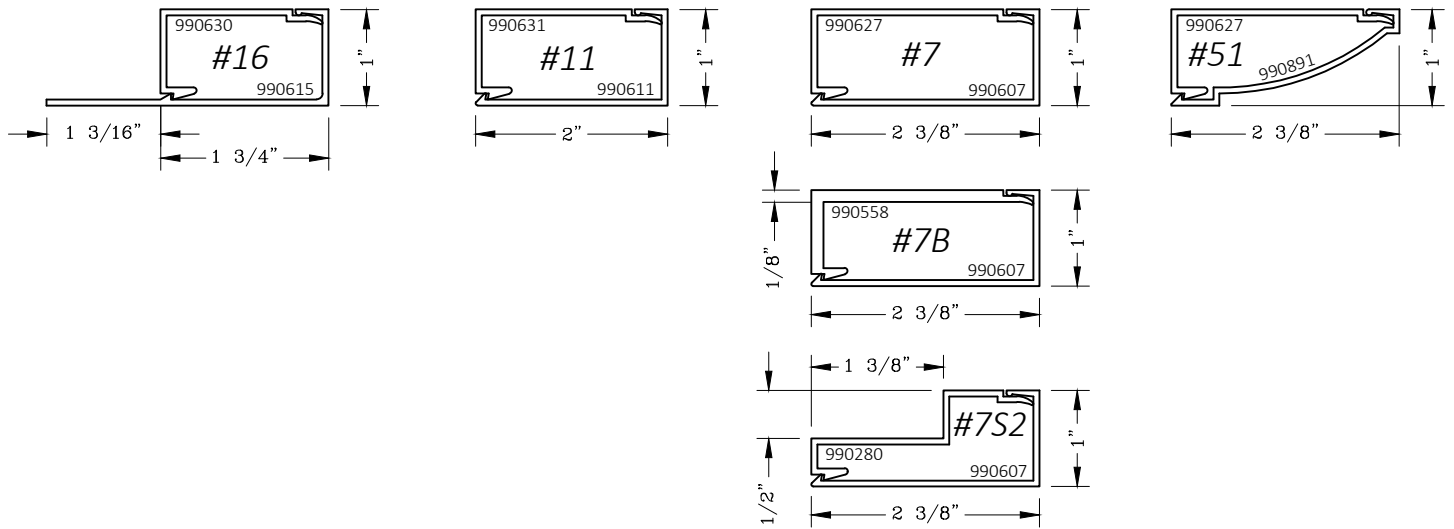
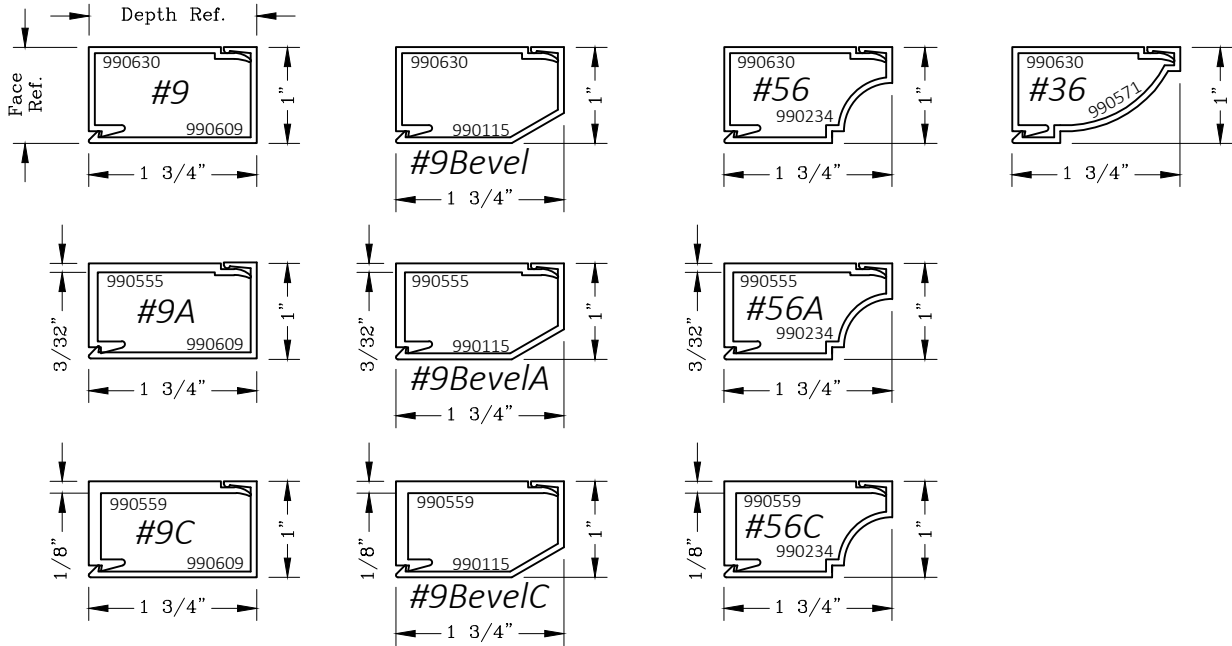

Graham Architectural Products reserves the right to change, add, cancel, remove or otherwise modify the details illustrated without prior notice.

1551 Mt. Rose Avenue, York, Pennsylvania 17403-2909 800/755-6274 Fax: 800/366-5097

Web Site: [www.grahamwindows.com](http://www.grahamwindows.com)

0920 – TR.01B

# Interior Trim Assemblies

## 1/2" To 1" Clip Face



Series:Accessories Manufacturing Code:TR01C

Drawing 1/2 Scale – For Custom Size Drawing Contact Graham

Note: Sealant Not Shown On Details. Refer To General Installation Instructions.

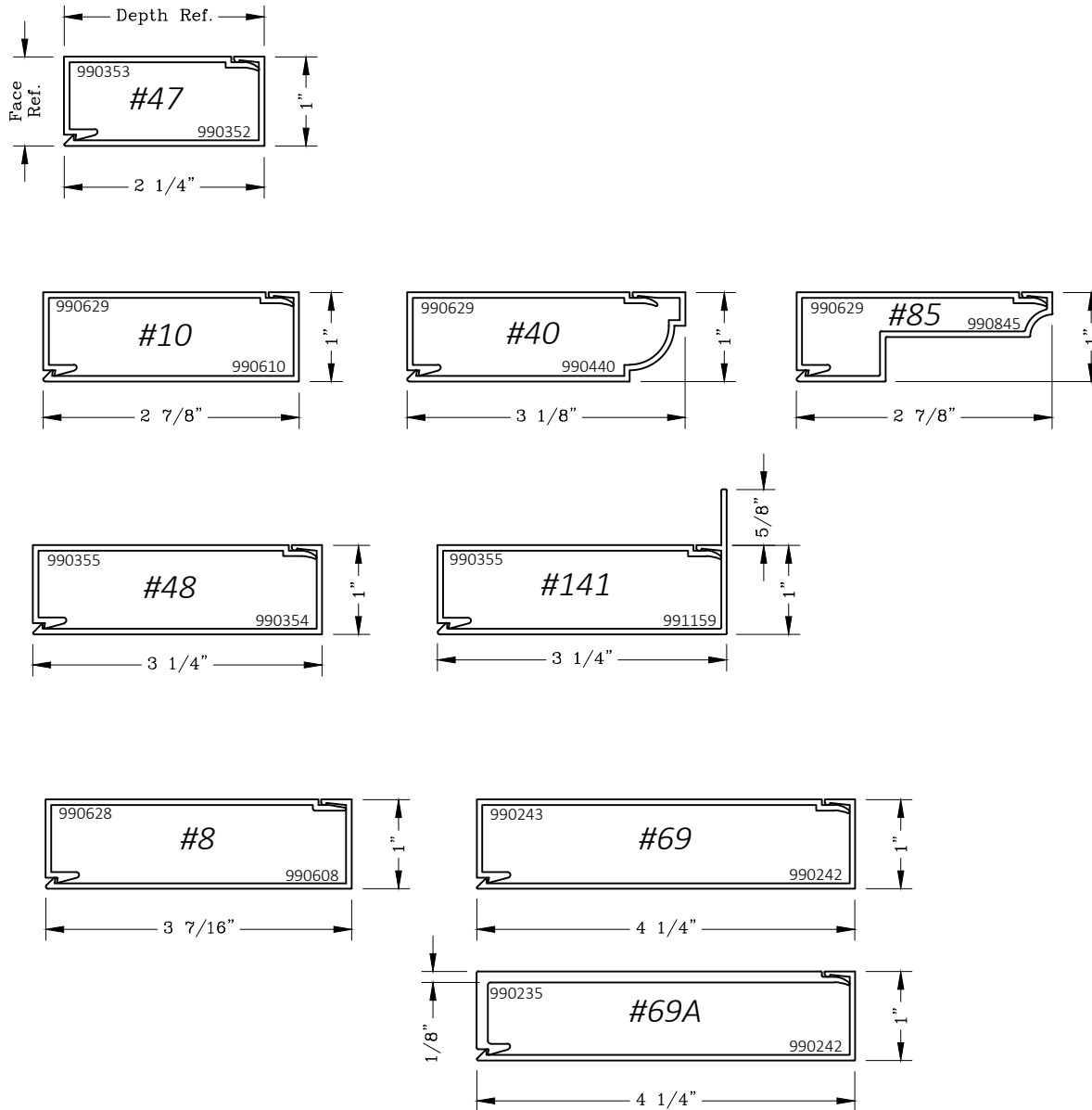

Graham Architectural Products reserves the right to change, add, cancel, remove or otherwise modify the details illustrated without prior notice.

1551 Mt. Rose Avenue, York, Pennsylvania 17403-2909 800/755-6274 Fax: 800/366-5097

Web Site: [www.grahamwindows.com](http://www.grahamwindows.com)

0222 - TR.01C

# Interior Trim Assemblies

## 1" To 2" Clip Face



Series:Accessories Manufacturing Code:TR02A

Drawing 1/2 Scale – For Custom Size Drawing Contact Graham

Note: Sealant Not Shown On Details. Refer To General Installation Instructions.

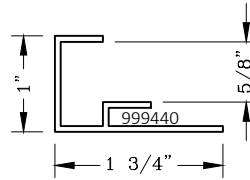

5/8" Drywall Trim

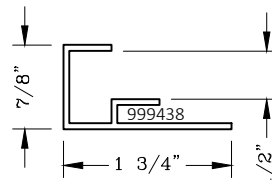

1/2" Drywall Trim

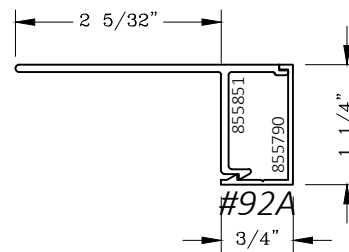
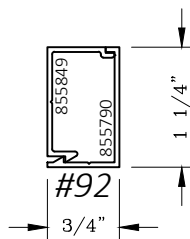
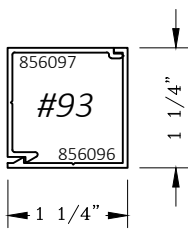
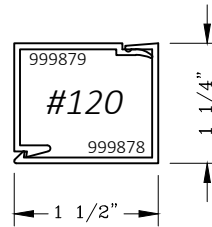
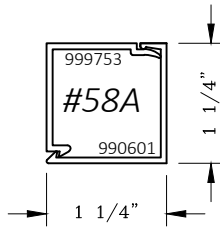
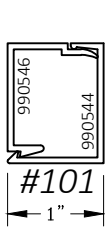
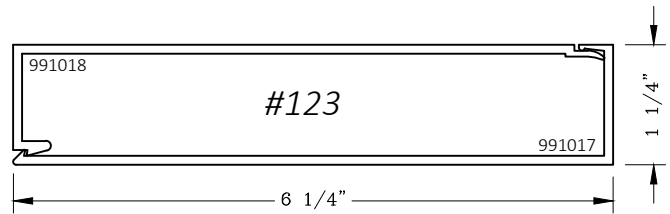
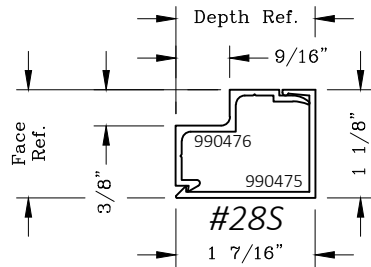

Graham Architectural Products reserves the right to change, add, cancel, remove or otherwise modify the details illustrated without prior notice.

1551 Mt. Rose Avenue, York, Pennsylvania 17403-2909 800/755-6274 Fax: 800/366-5097

1021 - TR.02A

Web Site: [www.grahamwindows.com](http://www.grahamwindows.com)

# Interior Trim Assemblies 1" To 2" Clip Face



Series:Accessories Manufacturing Code:TR02B

Drawing 1/2 Scale – For Custom Size Drawing Contact Graham

Note: Sealant Not Shown On Details. Refer To General Installation Instructions.

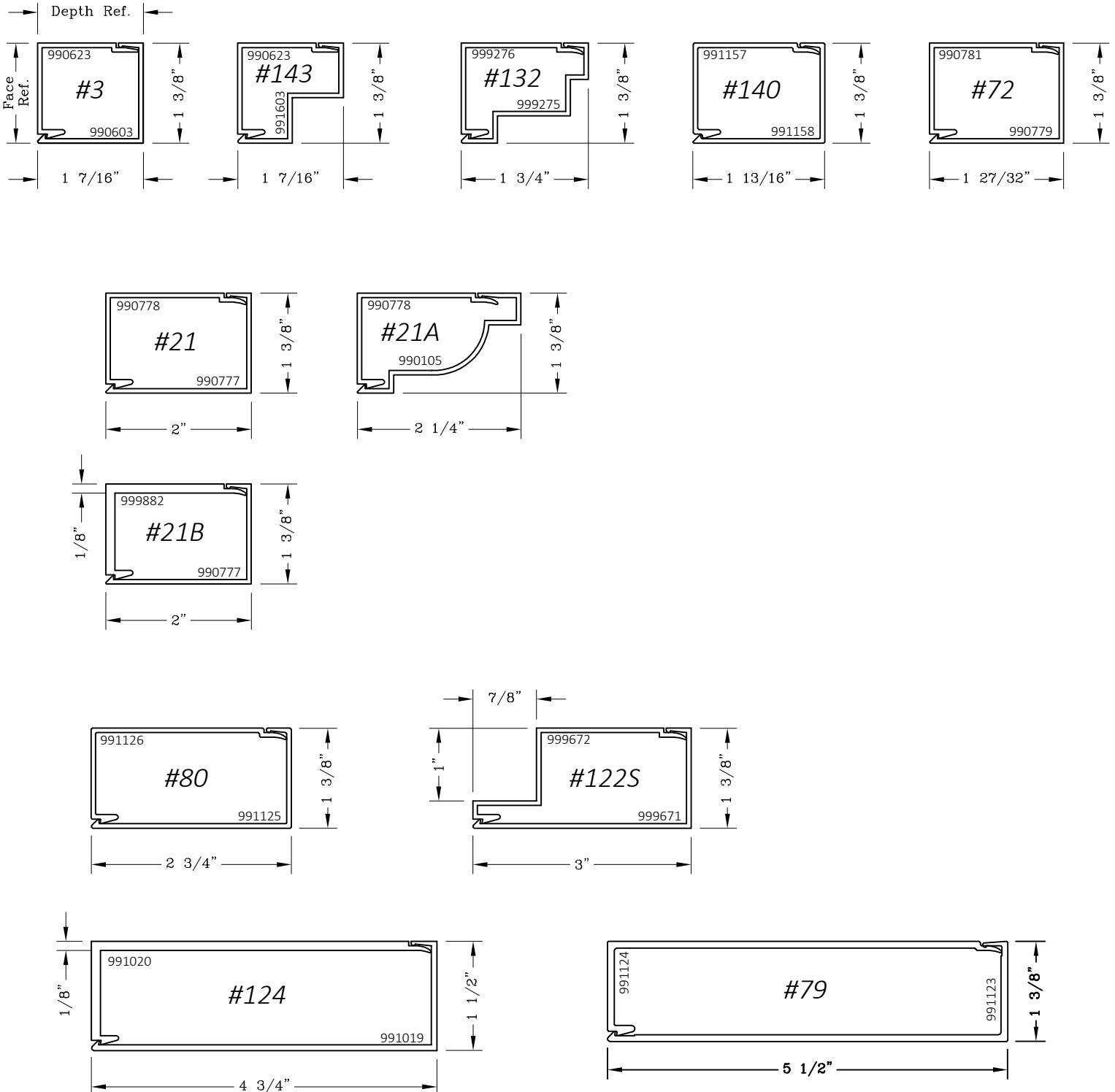

Graham Architectural Products reserves the right to change, add, cancel, remove or otherwise modify the details illustrated without prior notice.

1551 Mt. Rose Avenue, York, Pennsylvania 17403-2909 800/755-6274 Fax: 800/366-5097

Web Site: [www.grahamwindows.com](http://www.grahamwindows.com)

0622 – TR.02B

# Interior Trim Assemblies 1" To 2" Clip Face



Series:Accessories Manufacturing Code:TR02C

Drawing 1/2 Scale – For Custom Size Drawing Contact Graham

Note: Sealant Not Shown On Details. Refer To General Installation Instructions.

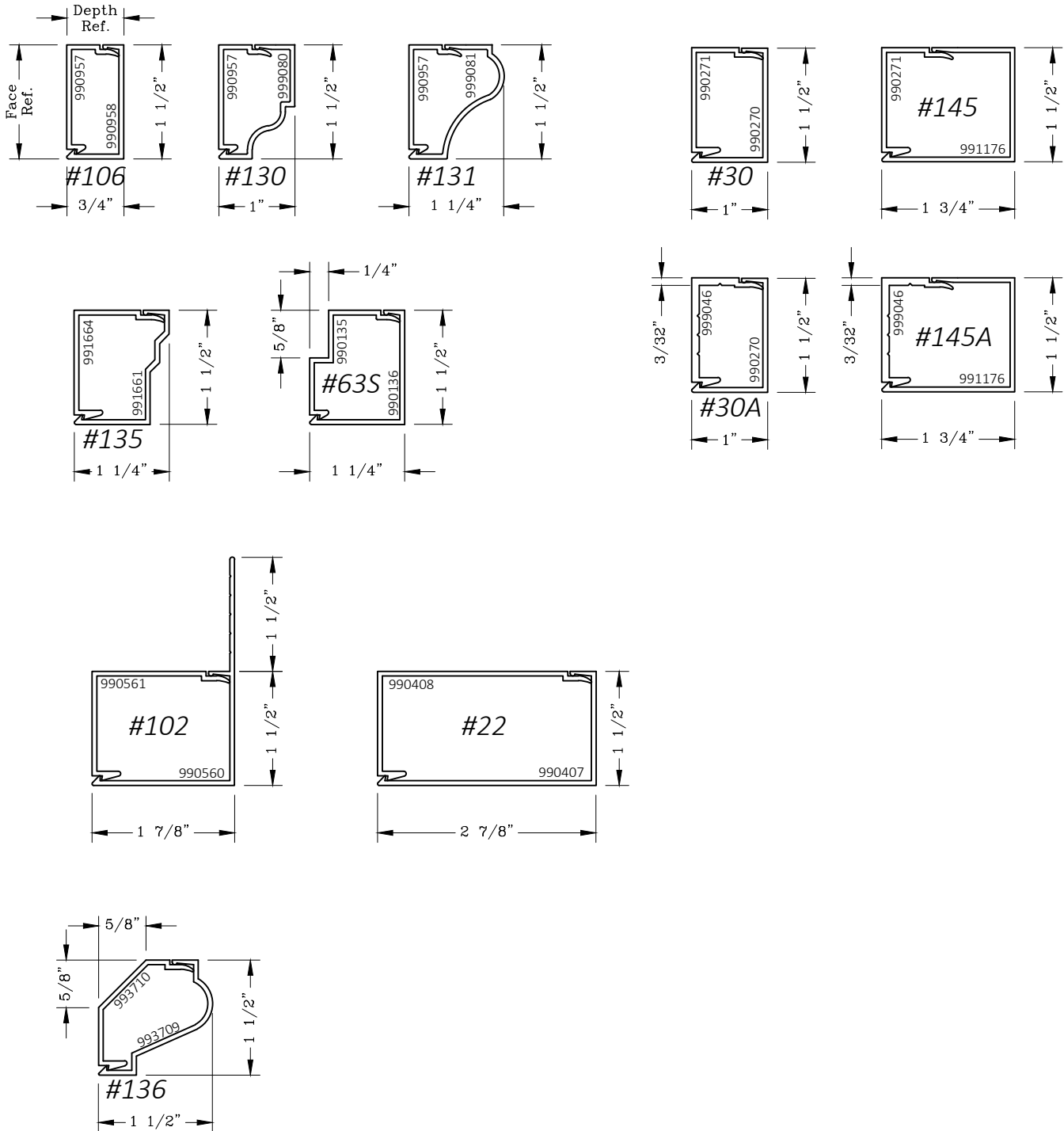

Graham Architectural Products reserves the right to change, add, cancel, remove or otherwise modify the details illustrated without prior notice.

1551 Mt. Rose Avenue, York, Pennsylvania 17403-2909 800/755-6274 Fax: 800/366-5097

Web Site: [www.grahamwindows.com](http://www.grahamwindows.com)

0920 – TR.02C

# Interior Trim Assemblies

## 1" To 2" Clip Face



Series:Accessories Manufacturing Code:TR02D

Drawing 1/2 Scale – For Custom Size Drawing Contact Graham

Note: Sealant Not Shown On Details. Refer To General Installation Instructions.

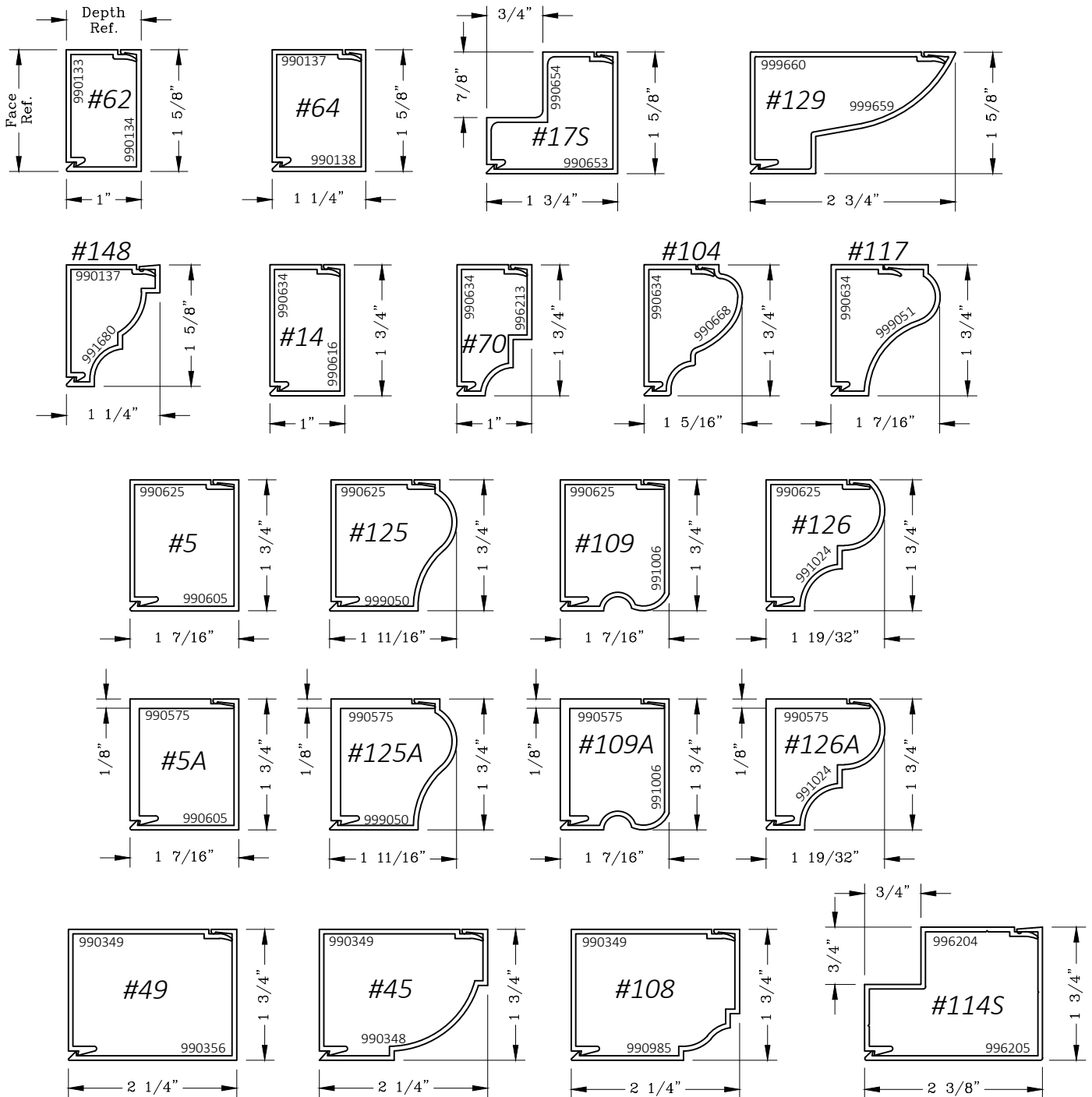

Graham Architectural Products reserves the right to change, add, cancel, remove or otherwise modify the details illustrated without prior notice.

1551 Mt. Rose Avenue, York, Pennsylvania 17403-2909 800/755-6274 Fax: 800/366-5097

Web Site: [www.grahamwindows.com](http://www.grahamwindows.com)

0920 - TR.02D

# Interior Trim Assemblies

## 1" To 2" Clip Face



Series:Accessories Manufacturing Code:TR02E

Drawing 1/2 Scale – For Custom Size Drawing Contact Graham

Note: Sealant Not Shown On Details. Refer To General Installation Instructions.

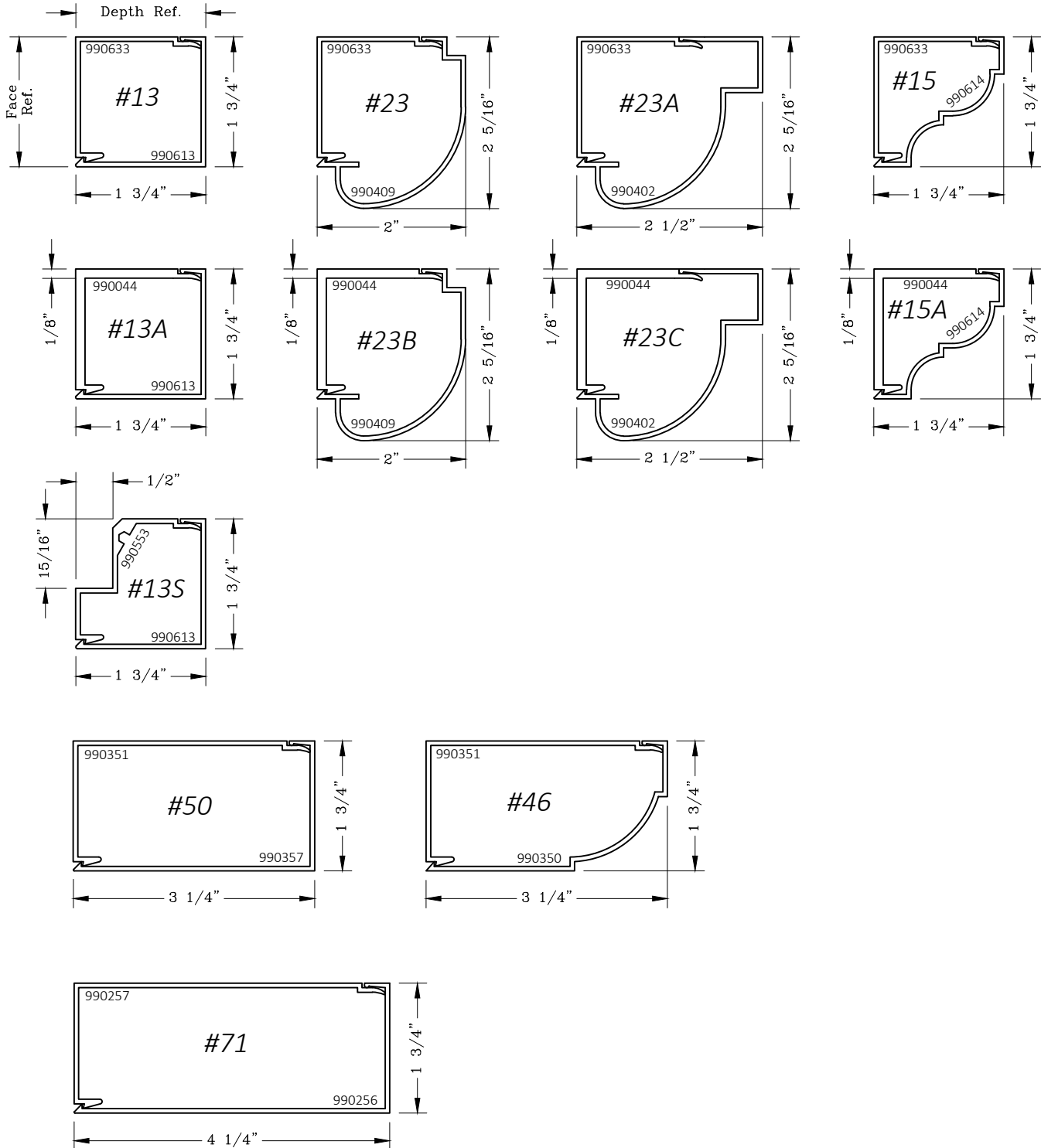

Graham Architectural Products reserves the right to change, add, cancel, remove or otherwise modify the details illustrated without prior notice.

1551 Mt. Rose Avenue, York, Pennsylvania 17403-2909 800/755-6274 Fax: 800/366-5097

Web Site: [www.grahamwindows.com](http://www.grahamwindows.com)

0920 – TR.02E



# Interior Trim Assemblies

## 1" To 2" Clip Face



Series:Accessories Manufacturing Code:TR02F

Drawing 1/2 Scale – For Custom Size Drawing Contact Graham

Note: Sealant Not Shown On Details. Refer To General Installation Instructions.

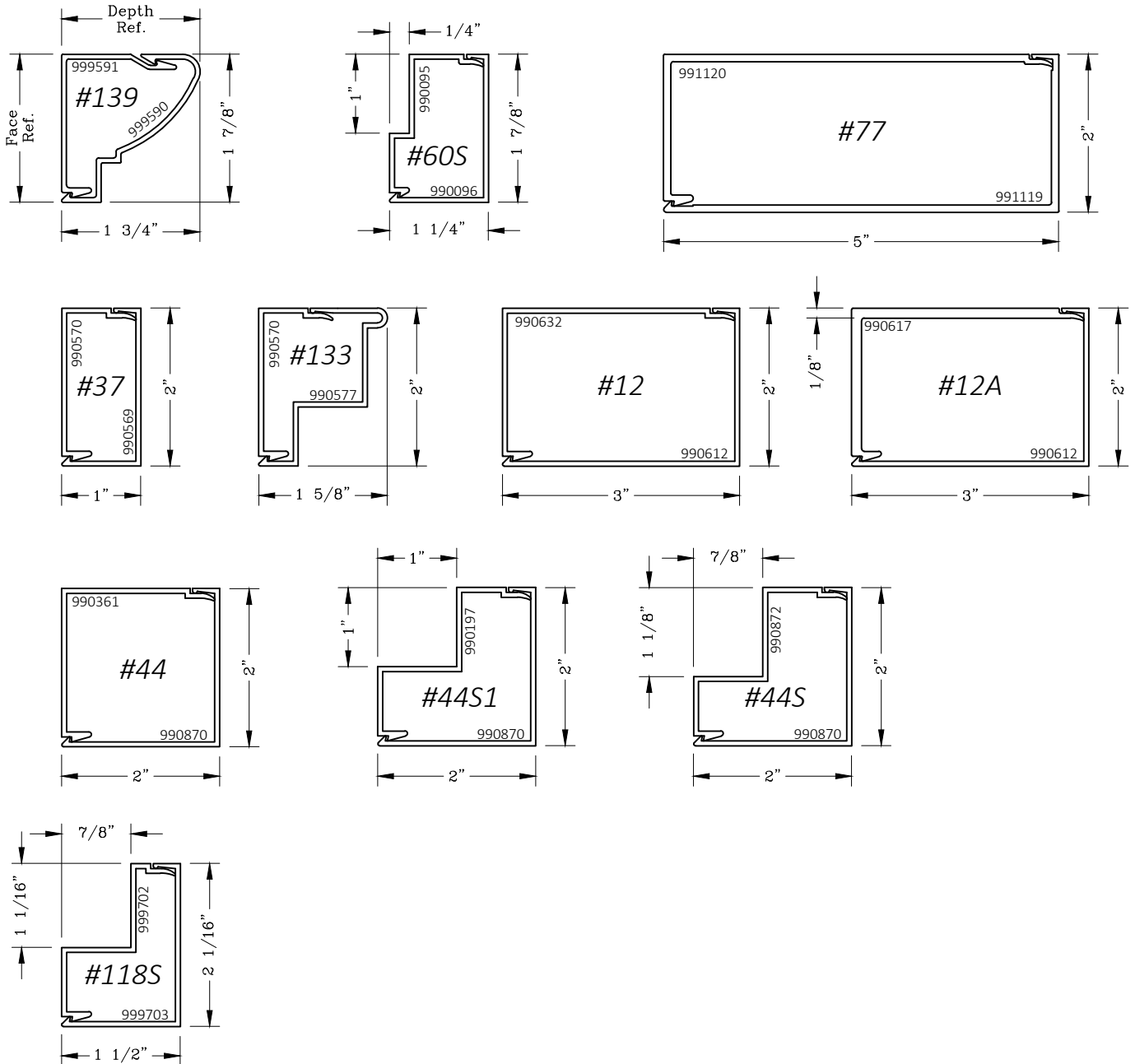

Graham Architectural Products reserves the right to change, add, cancel, remove or otherwise modify the details illustrated without prior notice.

1551 Mt. Rose Avenue, York, Pennsylvania 17403-2909 800/755-6274 Fax: 800/366-5097

1021 - TR.02F

Web Site: [www.grahamwindows.com](http://www.grahamwindows.com)

# Interior Trim Assemblies 2" To 3" Clip Face



Series:Accessories Manufacturing Code:TR03A

Drawing 1/2 Scale – For Custom Size Drawing Contact Graham

Note: Sealant Not Shown On Details. Refer To General Installation Instructions.

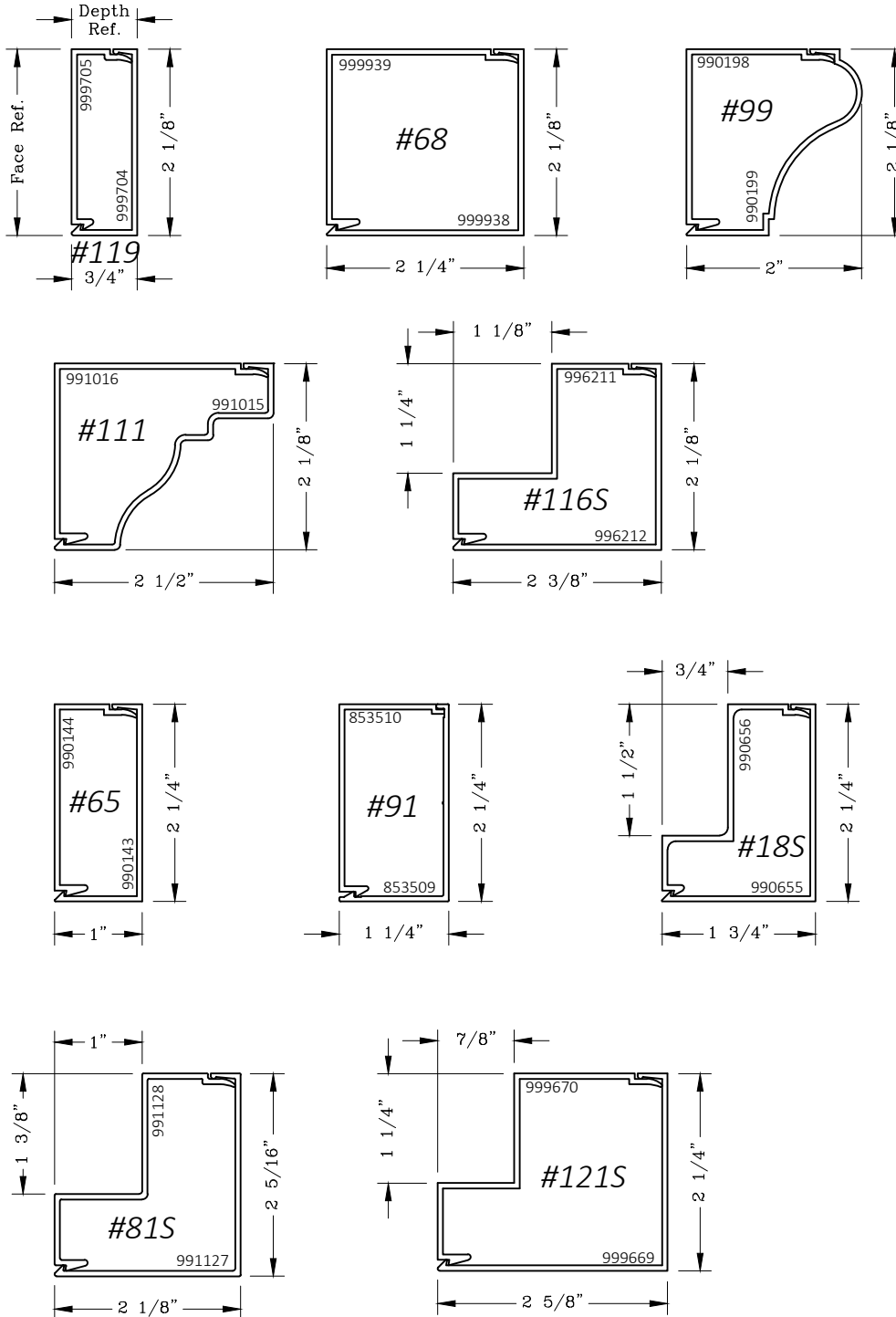

Graham Architectural Products reserves the right to change, add, cancel, remove or otherwise modify the details illustrated without prior notice.

1551 Mt. Rose Avenue, York, Pennsylvania 17403-2909 800/755-6274 Fax: 800/366-5097

Web Site: [www.grahamwindows.com](http://www.grahamwindows.com)

# Interior Trim Assemblies 2" To 3" Clip Face



Series:Accessories Manufacturing Code:TR03B

Drawing 1/2 Scale – For Custom Size Drawing Contact Graham

Note: Sealant Not Shown On Details. Refer To General Installation Instructions.

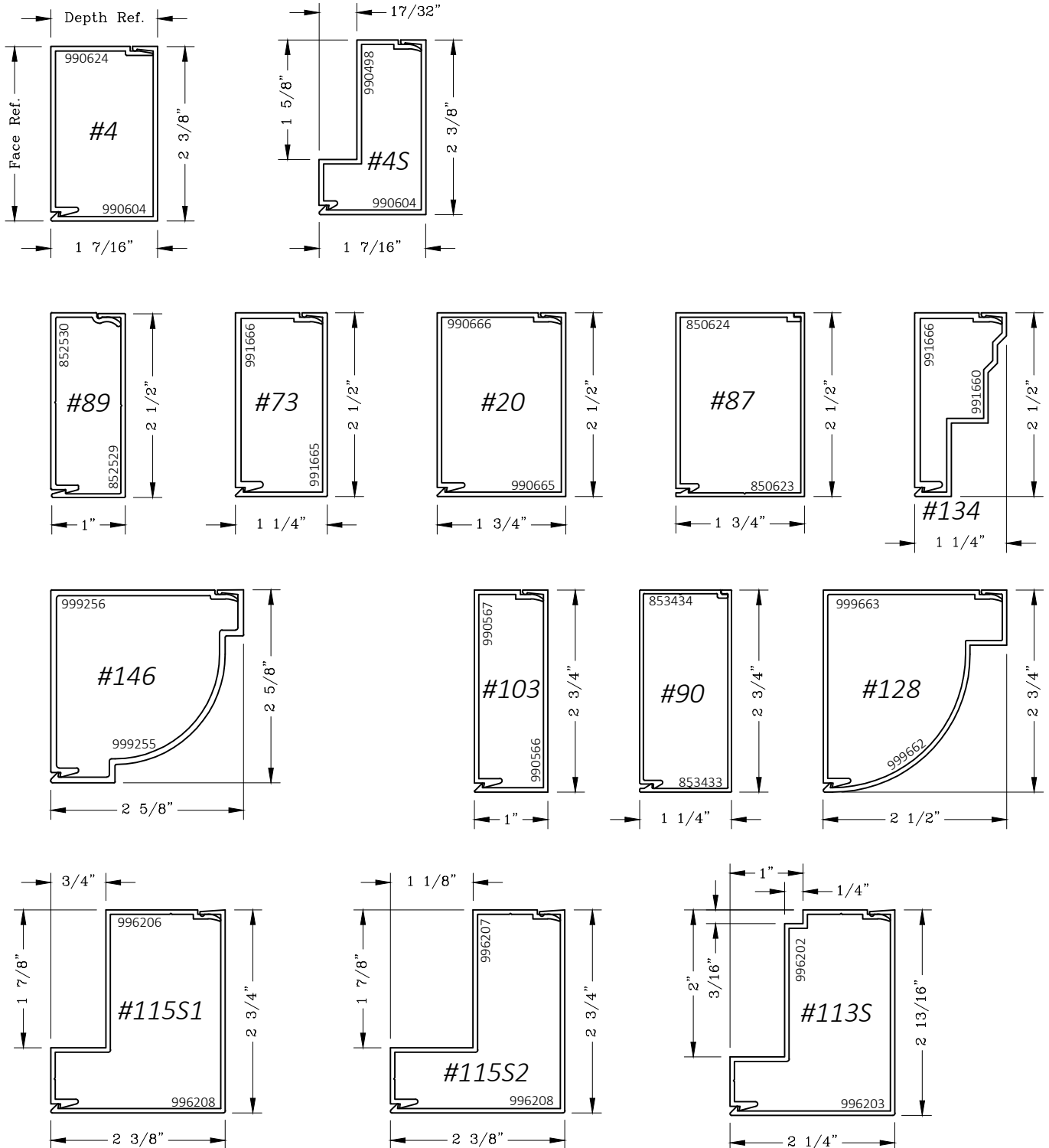

Graham Architectural Products reserves the right to change, add, cancel, remove or otherwise modify the details illustrated without prior notice.

1551 Mt. Rose Avenue, York, Pennsylvania 17403-2909 800/755-6274 Fax: 800/366-5097

Web Site: [www.grahamwindows.com](http://www.grahamwindows.com)

0920 - TR.03B

# Interior Trim Assemblies 2" To 3" Clip Face



Series:Accessories Manufacturing Code:TR03C

Drawing 1/2 Scale – For Custom Size Drawing Contact Graham

Note: Sealant Not Shown On Details. Refer To General Installation Instructions.

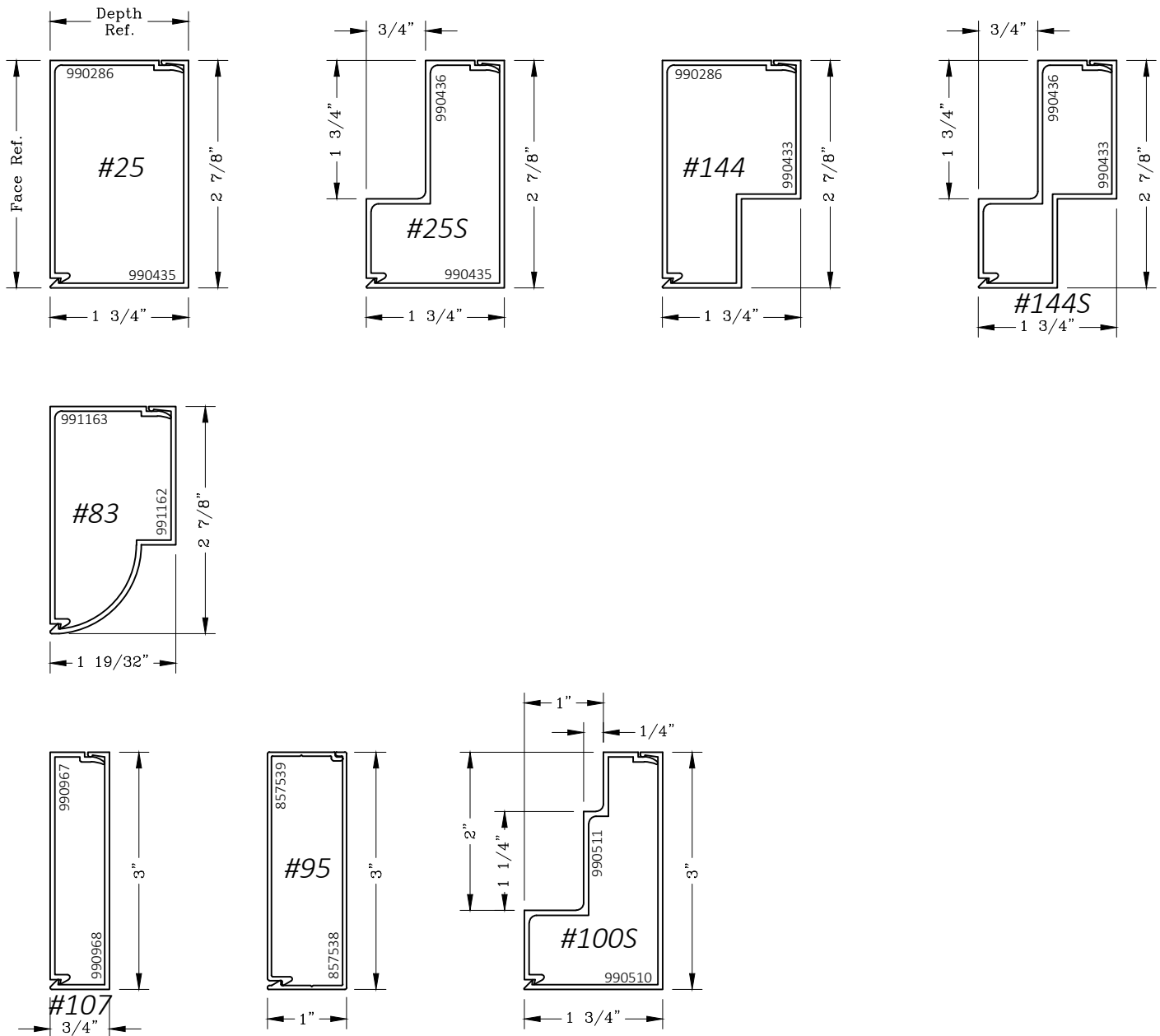

Graham Architectural Products reserves the right to change, add, cancel, remove or otherwise modify the details illustrated without prior notice.

1551 Mt. Rose Avenue, York, Pennsylvania 17403-2909 800/755-6274 Fax: 800/366-5097

0920 – TR.03C

Web Site: [www.grahamwindows.com](http://www.grahamwindows.com)

# Interior Trim Assemblies 3" And Larger Clip Face



Series:Accessories Manufacturing Code:TR04A

Drawing 1/2 Scale – For Custom Size Drawing Contact Graham

Note: Sealant Not Shown On Details. Refer To General Installation Instructions.

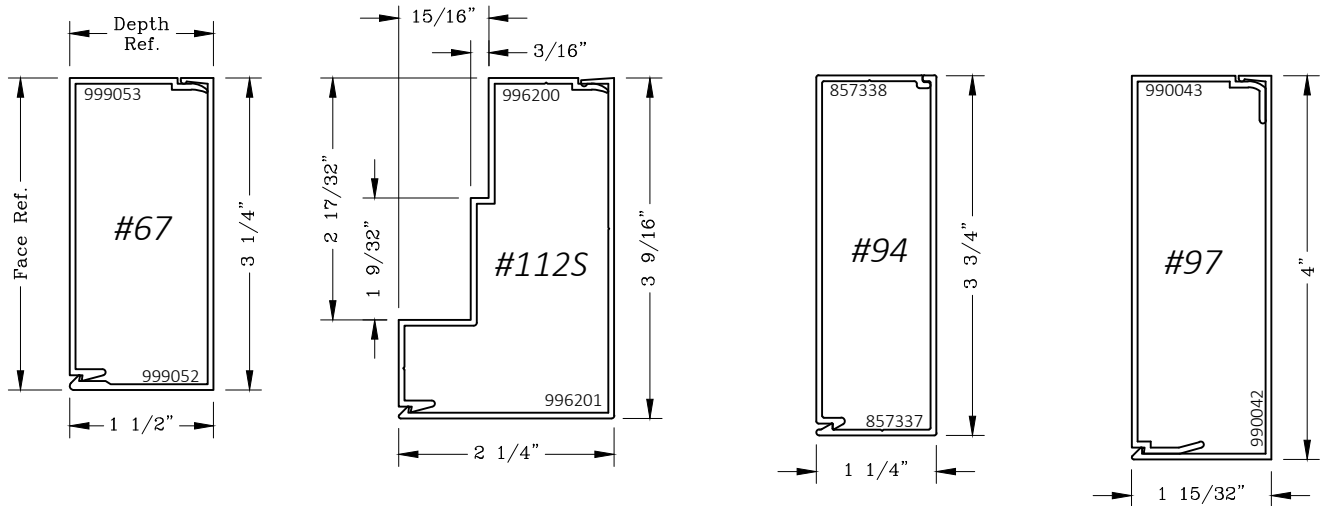

Graham Architectural Products reserves the right to change, add, cancel, remove or otherwise modify the details illustrated without prior notice.

1551 Mt. Rose Avenue, York, Pennsylvania 17403-2909 800/755-6274 Fax: 800/366-5097

Web Site: [www.grahamwindows.com](http://www.grahamwindows.com)

0920 – TR.04A