

Mullcovers Self Stacking/Base and Covers



Series: Accessories Manufacturing Code: MC01

Drawing 1/2 Scale – For Custom Size Drawing Contact Graham

Note: Sealant Not Shown On Details. Refer To General Installation Instructions.

SELF STACKING MULLIONS FOR EURO ACCESSORY TRACK

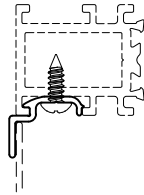

850289
Female Adapter

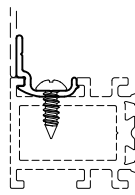

851290
Male Adapter

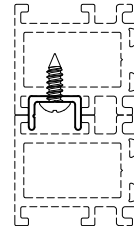

857202
"U" Stack Mullion

MULLION BASES & COVERS

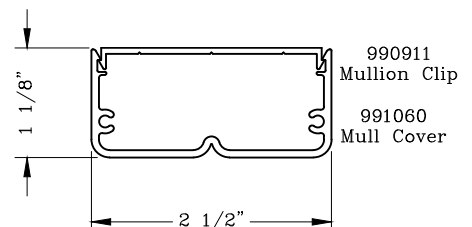
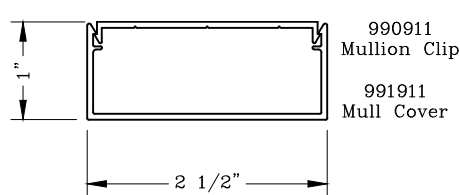
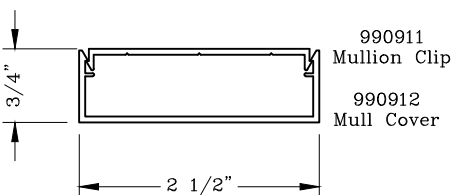
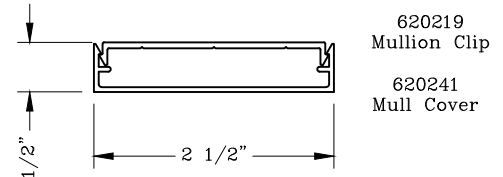
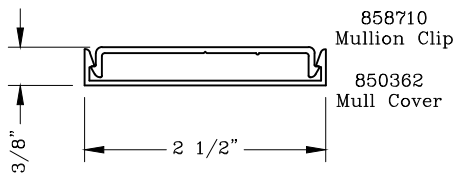
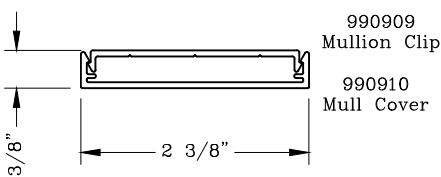
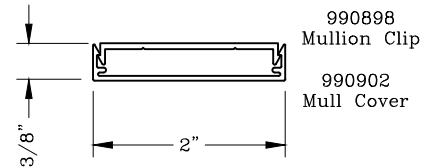
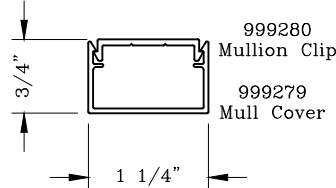
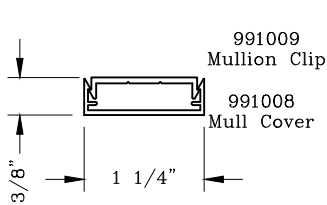

Graham Architectural Products reserves the right to change, add, cancel, remove or otherwise modify the details illustrated without prior notice.

1551 Mt. Rose Avenue, York, Pennsylvania 17403-2909 800/755-6274 Fax: 800/366-5097

0821 - MC.01

Web Site: www.grahamwindows.com

Mullcovers



Series: Accessories Manufacturing Code: MC02

Drawing 1/2 Scale – For Custom Size Drawing Contact Graham

Note: Sealant Not Shown On Details. Refer To General Installation Instructions.

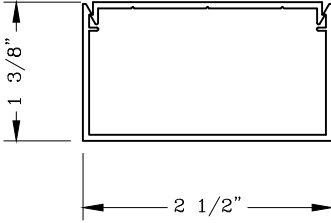

990911
Mullion Clip

991010
Mull Cover

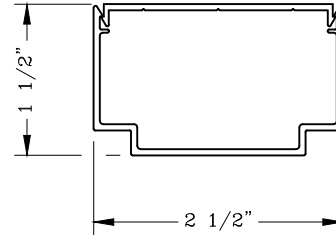

990911
Mullion Clip

991501
Mull Cover

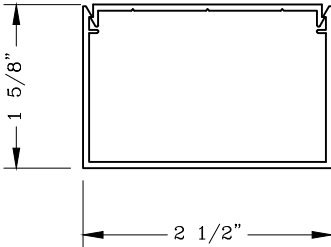

990911
Mullion Clip

991011
Mull Cover

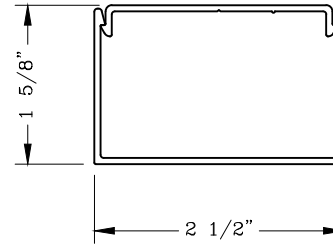

858710
Mullion Clip

858709
Mull Cover

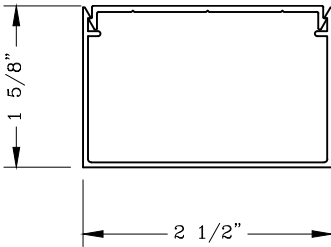

620219
Mullion Clip

620240
Mull Cover

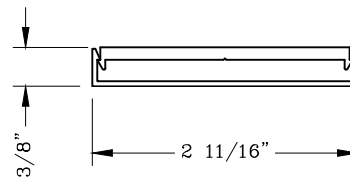

990900
Mullion Clip

990642
Mull Cover

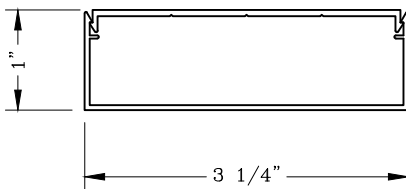

990907
Mullion Clip

990906
Mull Cover

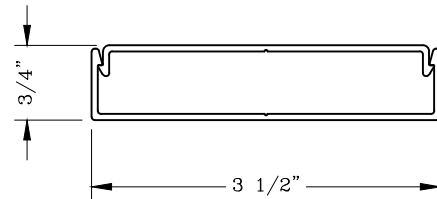

851640
Mullion Clip

851639
Mull Cover

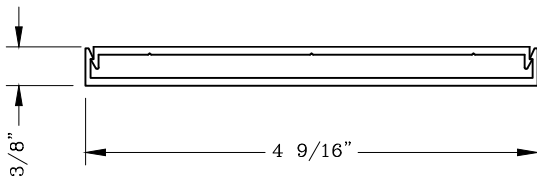

990927
Mullion Clip

630107
Mull Cover

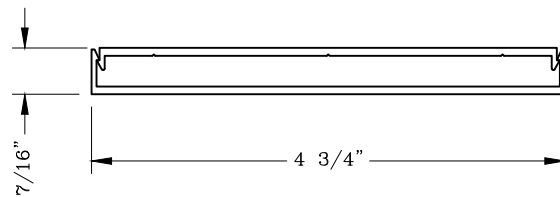

990771
Mullion Clip

990770
Mull Cover

Graham Architectural Products reserves the right to change, add, cancel, remove or otherwise modify the details illustrated without prior notice.

1551 Mt. Rose Avenue, York, Pennsylvania 17403-2909 800/755-6274 Fax: 800/366-5097

0821 – MC02

Web Site: www.grahamwindows.com

Series: Accessories Manufacturing Code: MC03

Drawing 1/2 Scale – For Custom Size Drawing Contact Graham

Note: Sealant Not Shown On Details. Refer To General Installation Instructions.

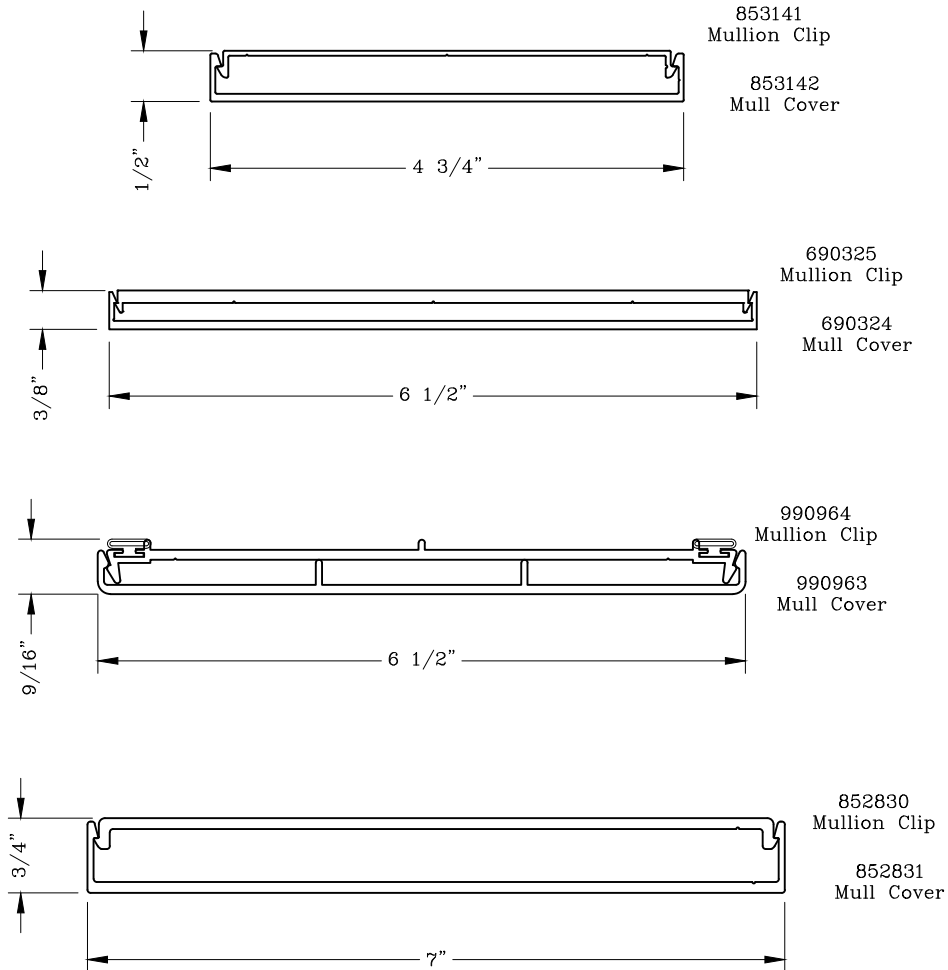

Series: Accessories Manufacturing Code: MC04

Drawing 1/2 Scale – For Custom Size Drawing Contact Graham

Note: Sealant Not Shown On Details. Refer To General Installation Instructions.

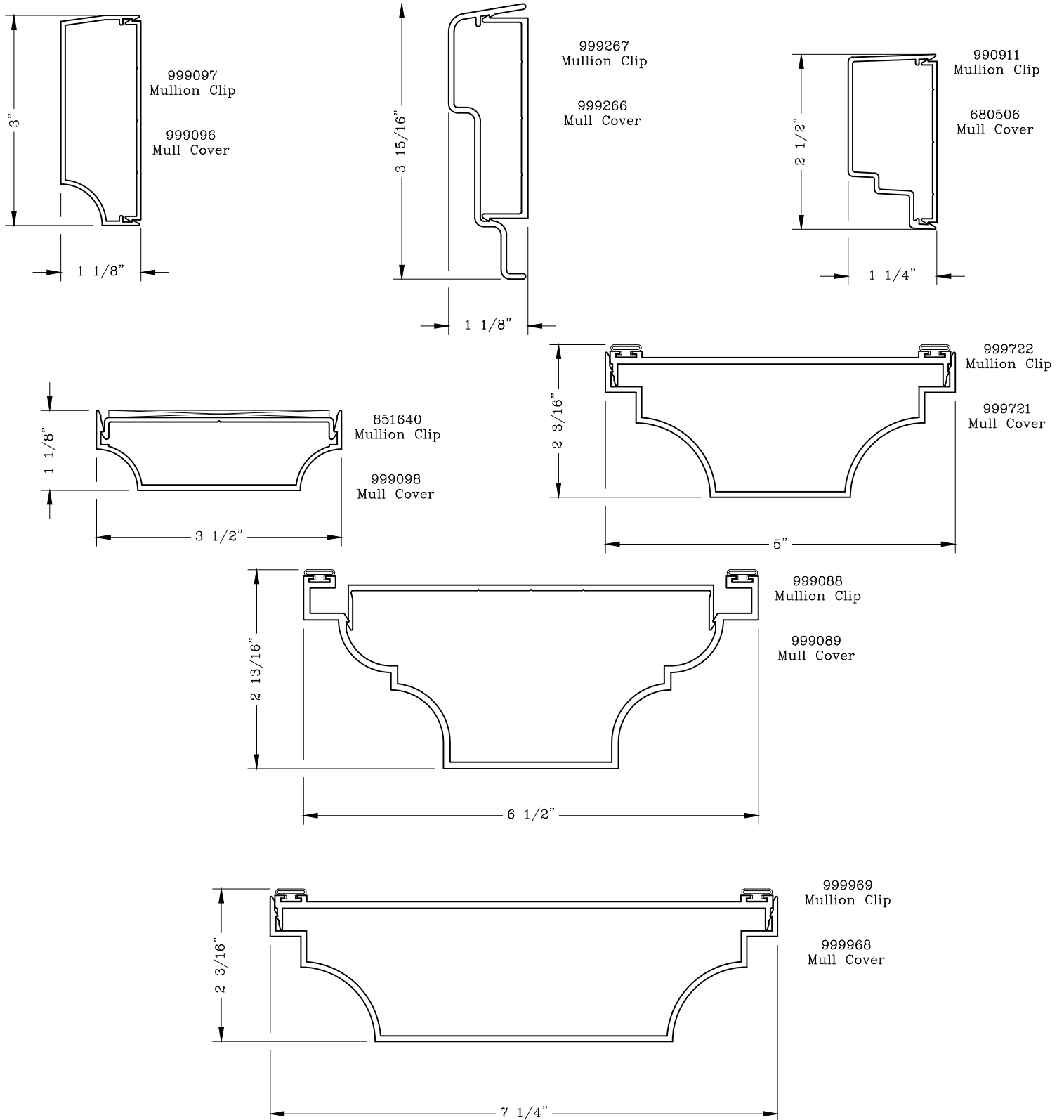

Graham Architectural Products reserves the right to change, add, cancel, remove or otherwise modify the details illustrated without prior notice.

1551 Mt. Rose Avenue, York, Pennsylvania 17403-2909 800/755-6274 Fax: 800/366-5097

0821 – MC04

Web Site: www.grahamwindows.com

Mullcovers



Series: Accessories Manufacturing Code: MC05

Drawing 1/2 Scale – For Custom Size Drawing Contact Graham

Note: Sealant Not Shown On Details. Refer To General Installation Instructions.

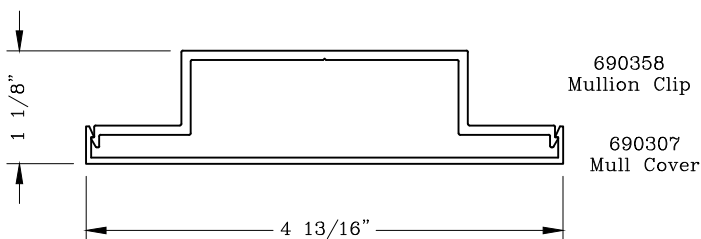
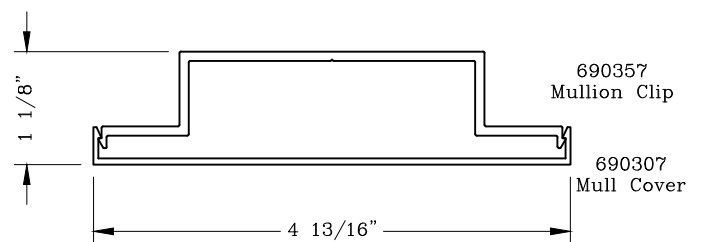
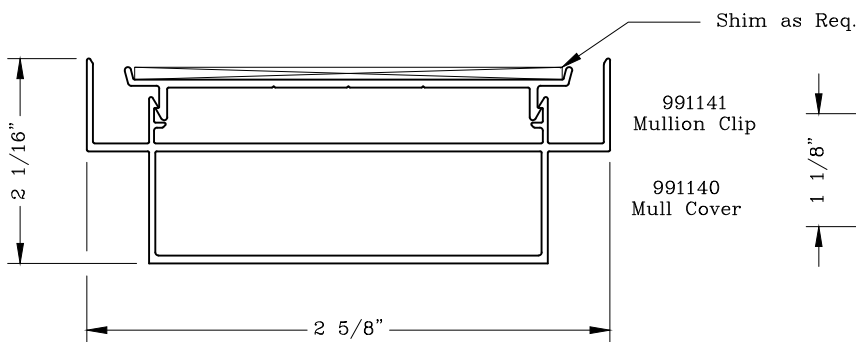
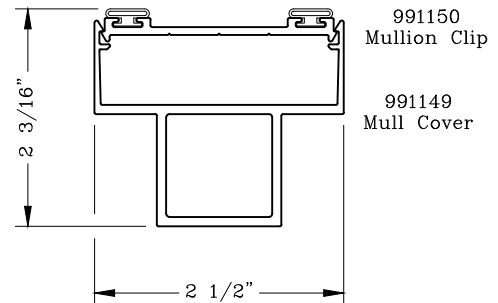
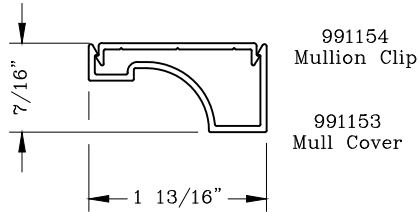

Graham Architectural Products reserves the right to change, add, cancel, remove or otherwise modify the details illustrated without prior notice.

1551 Mt. Rose Avenue, York, Pennsylvania 17403-2909 800/755-6274 Fax: 800/366-5097

0821 – MC05

Web Site: www.grahamwindows.com

Mullcovers



Series: Accessories Manufacturing Code: MC06

Drawing 1/2 Scale – For Custom Size Drawing Contact Graham

Note: Sealant Not Shown On Details. Refer To General Installation Instructions.

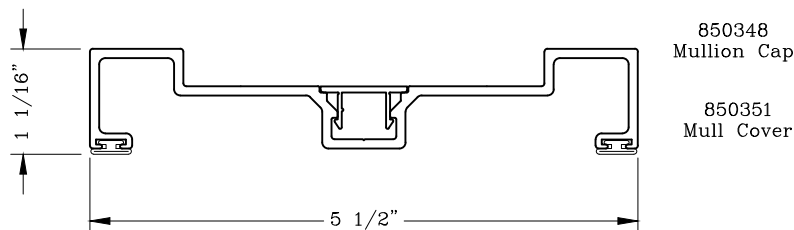
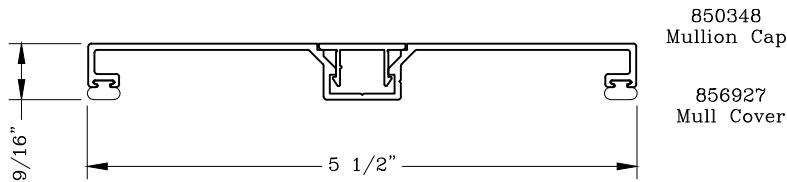
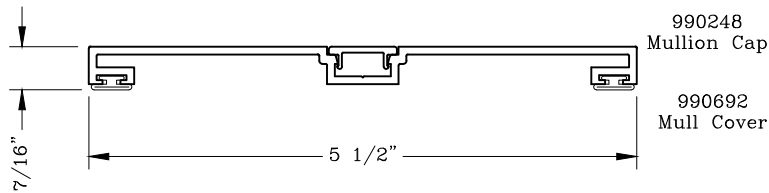
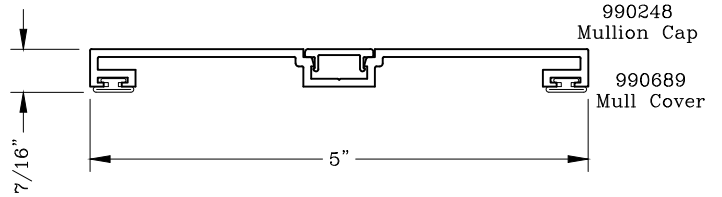
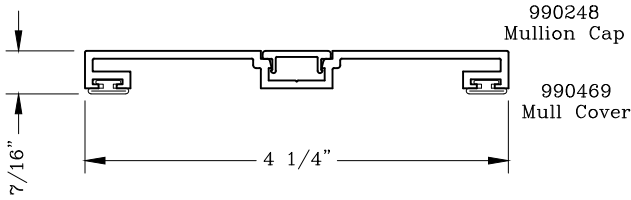
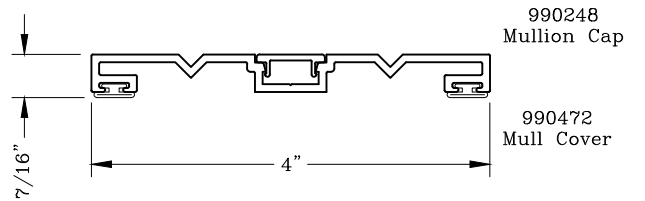
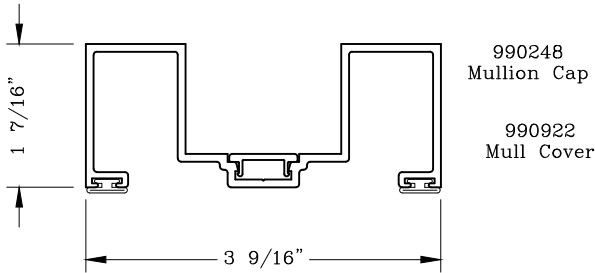
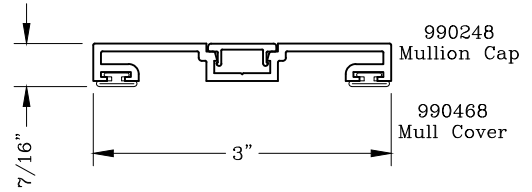
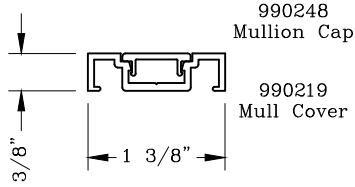

Graham Architectural Products reserves the right to change, add, cancel, remove or otherwise modify the details illustrated without prior notice.

1551 Mt. Rose Avenue, York, Pennsylvania 17403-2909 800/755-6274 Fax: 800/366-5097

0821 – MC.06

Web Site: www.grahamwindows.com

Mullcovers



Series: Accessories Manufacturing Code: MC07

Drawing 1/2 Scale – For Custom Size Drawing Contact Graham

Note: Sealant Not Shown On Details. Refer To General Installation Instructions.

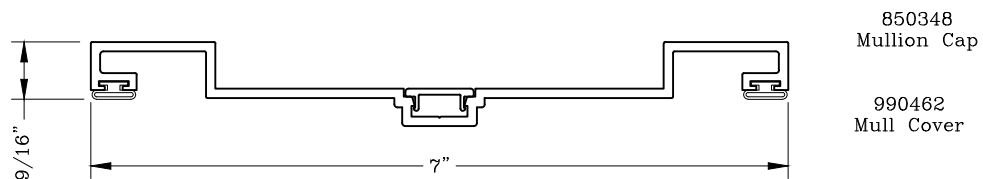
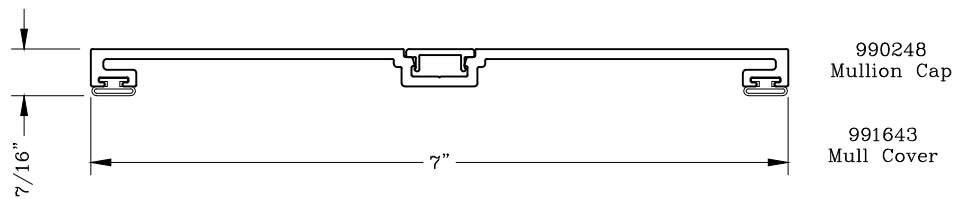
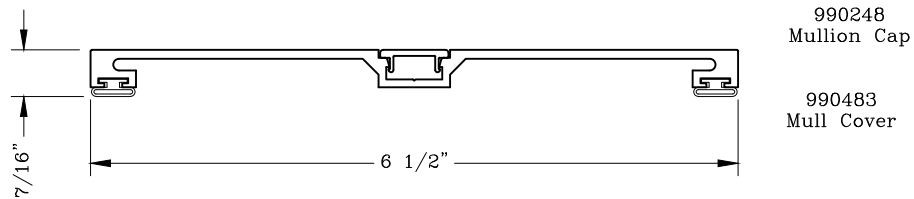

Graham Architectural Products reserves the right to change, add, cancel, remove or otherwise modify the details illustrated without prior notice.

1551 Mt. Rose Avenue, York, Pennsylvania 17403-2909 800/755-6274 Fax: 800/366-5097

0821 – MC07

Web Site: www.grahamwindows.com