

# Post Set Panning



Series: Manufacturing Code: PST01

Drawing 3/8 Scale – For Custom Size Drawing Contact Graham

Note: Sealant Not Shown On Details. Refer To General Installation Instructions.

Moody Post-Set Panning Head And Jambs		
Description	'A' Dim X 'B' Dim	Slope
Moody	5.500 X 4.206	-

Moody Post-Set Panning Head And Jambs		
Description	'A' Dim X 'B' Dim	Slope
Moody	5.500 X 4.206	-

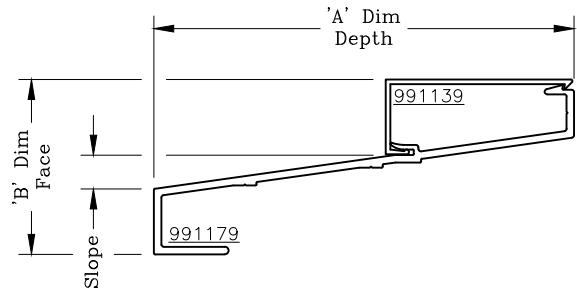
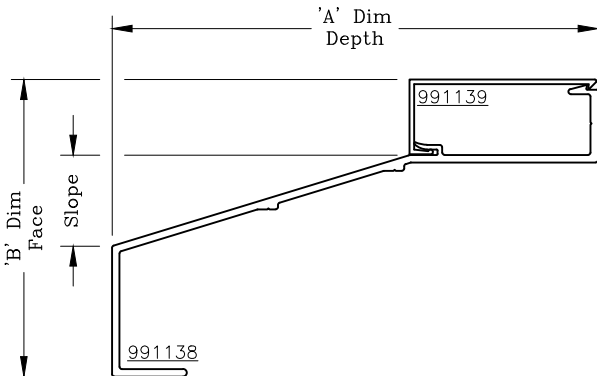
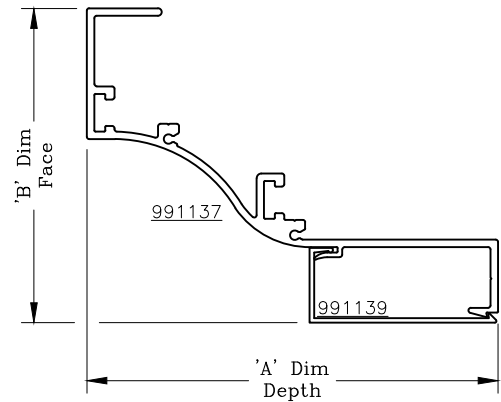
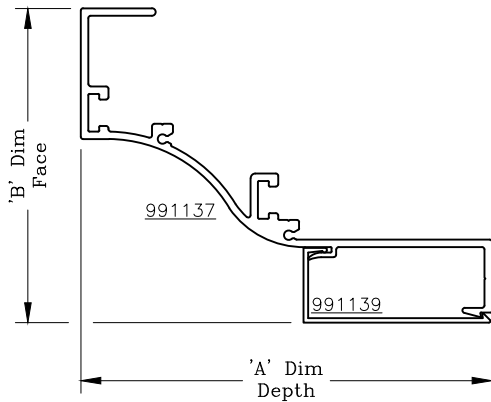

Moody Post-Set Panning Mating Sill		
Description	'A' Dim X 'B' Dim	Slope
Moody	6.500 X 3.976	1.219

Moody Post-Set Panning Mating Sill		
Description	'A' Dim X 'B' Dim	Slope
Reese-Phifer	5.625 X 2.340	.436

Graham Architectural Products reserves the right to change, add, cancel, remove or otherwise modify the details illustrated without prior notice.

1551 Mt. Rose Avenue, York, Pennsylvania 17403-2909 800/755-6274 Fax: 800/366-5097

Web Site: [www.grahamwindows.com](http://www.grahamwindows.com)

0522 - PST.01

# Post Set Panning



Series: Manufacturing Code: PST02

Drawing 3/8 Scale – For Custom Size Drawing Contact Graham

Note: Sealant Not Shown On Details. Refer To General Installation Instructions.

Labcorp Post-Set Panning Head And Jambs		
Description	'A' Dim X 'B' Dim	Slope
Labcorp	3.594 X 3.000	–

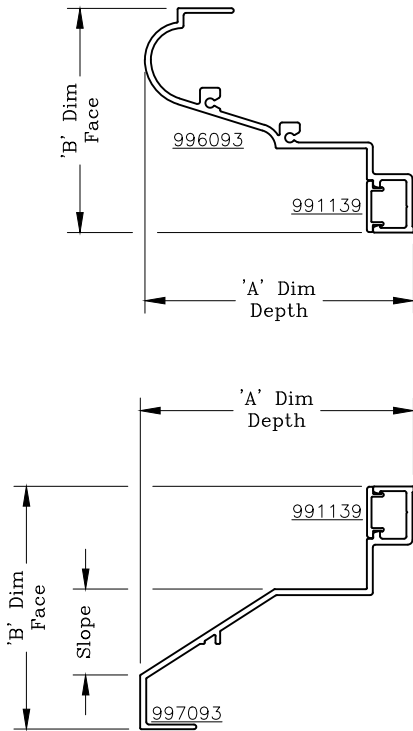

Labcorp Post-Set Panning Mating Sill		
Description	'A' Dim X 'B' Dim	Slope
Labcorp	3.657 X 3.250	1.151

Graham Architectural Products reserves the right to change, add, cancel, remove or otherwise modify the details illustrated without prior notice.

1551 Mt. Rose Avenue, York, Pennsylvania 17403-2909 800/755-6274 Fax: 800/366-5097

0522 – PST.02

Web Site: [www.grahamwindows.com](http://www.grahamwindows.com)

# Post Set Panning



Series: Manufacturing Code: PST03

Drawing 3/8 Scale – For Custom Size Drawing Contact Graham

Note: Sealant Not Shown On Details. Refer To General Installation Instructions.

Sheathing, Not By Graham,  
Can Be Attached To Clips  
Prior To Panning Installation  
For Window Protection  
During Ongoing Construction

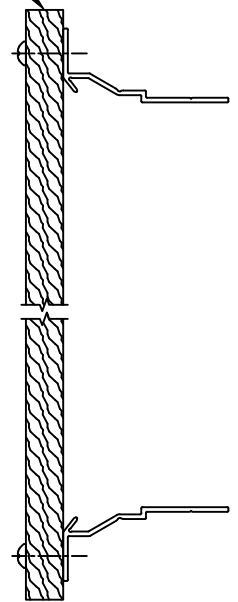

Wareham Large Post-Set Panning Head And Jambs		
Description	'A' Dim X 'B' Dim	Slope
Wareham Large	3.413 X 1.062	-

Wareham Small Post-Set Panning Head And Jambs		
Description	'A' Dim X 'B' Dim	Slope
Wareham Small	1.913 X 1.062	-

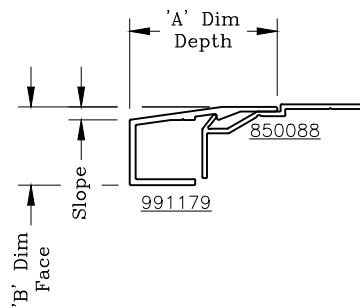
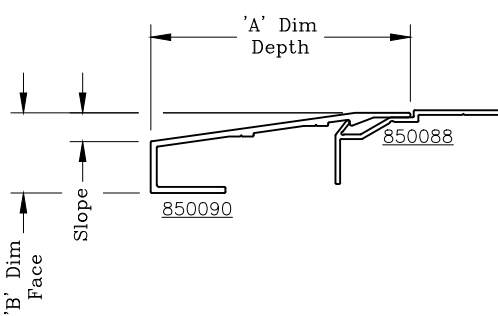
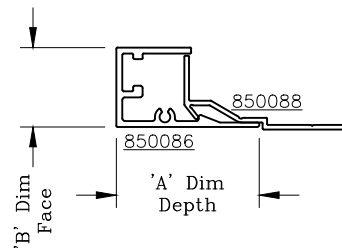
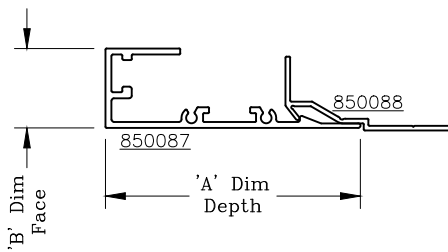

Wareham Large Post-Set Panning Mating Sill		
Description	'A' Dim X 'B' Dim	Slope
Wareham Large	3.475 X 1.072	.384

Wareham Small Post-Set Panning Mating Sill		
Description	'A' Dim X 'B' Dim	Slope
Wareham Small	1.975 X 1.047	.174

Graham Architectural Products reserves the right to change, add, cancel, remove or otherwise modify the details illustrated without prior notice.

1551 Mt. Rose Avenue, York, Pennsylvania 17403-2909 800/755-6274 Fax: 800/366-5097

Web Site: [www.grahamwindows.com](http://www.grahamwindows.com)

0522 - PST.03

# Post Set Panning



Series: Manufacturing Code: PST04

Drawing 3/8 Scale – For Custom Size Drawing Contact Graham

Note: Sealant Not Shown On Details. Refer To General Installation Instructions.

Camden Post-Set Panning Head And Jambs		
Description	'A' Dim X 'B' Dim	Slope
Camden	7.609 X 1.938	–

Sheathing, Not By Graham,  
Can Be Attached To Clips  
Prior To Panning Installation  
For Window Protection  
During Ongoing Construction

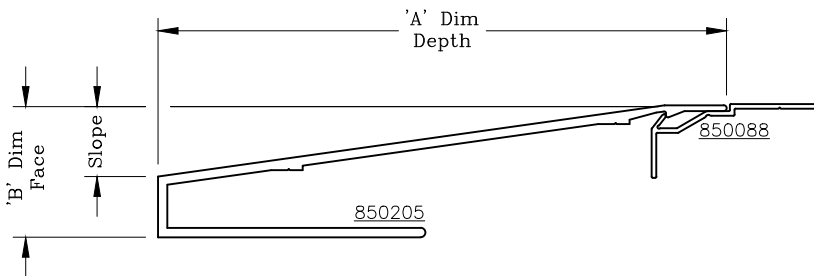
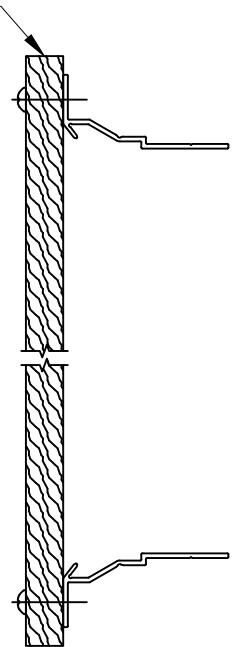
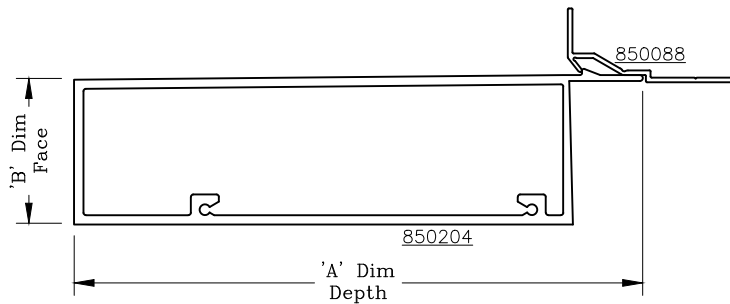

Camden Post-Set Panning Mating Sill		
Description	'A' Dim X 'B' Dim	Slope
Camden	7.611 X 1.765	.953

# Post Set Panning



Series: Manufacturing Code: PST05

Drawing 3/8 Scale – For Custom Size Drawing Contact Graham

Note: Sealant Not Shown On Details. Refer To General Installation Instructions.

Boylston Post-Set Panning Head And Jambs		
Description	'A' Dim X 'B' Dim	Slope
Boylston	5.221 X 1.500	-

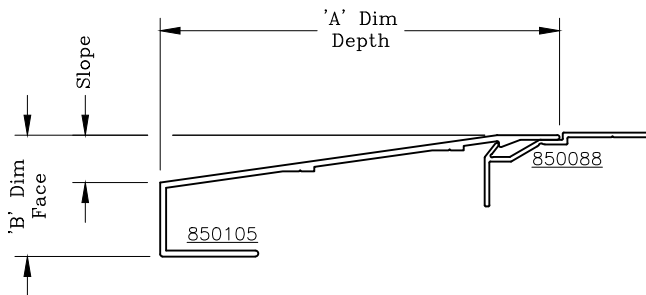
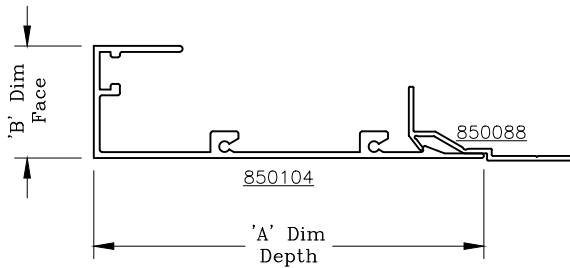

Boylston Post-Set Panning Mating Sill		
Description	'A' Dim X 'B' Dim	Slope
Boylston	5.346 X 1.625	.634

Sheathing, Not By Graham,  
Can Be Attached To Clips  
Prior To Panning Installation  
For Window Protection  
During Ongoing Construction

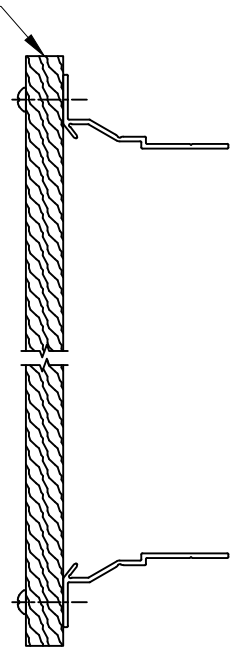

# Post Set Panning



Series: Manufacturing Code: PST06

Drawing 3/8 Scale – For Custom Size Drawing Contact Graham

Note: Sealant Not Shown On Details. Refer To General Installation Instructions.

Boylston Post-Set Panning Head And Jamb		
Description	'A' Dim X 'B' Dim	Slope
Boylston	5.221 X 1.500	-

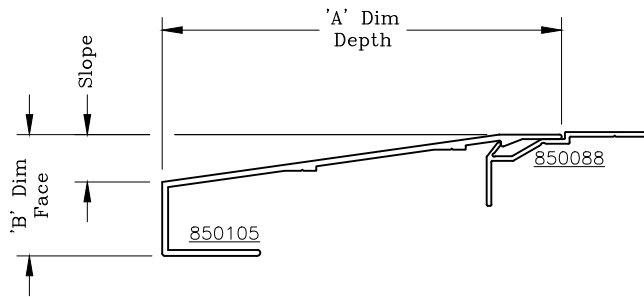
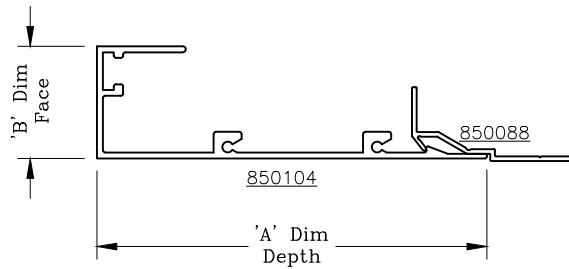

Boylston Post-Set Panning Mating Sill		
Description	'A' Dim X 'B' Dim	Slope
Boylston	5.346 X 1.625	.634

# Post Set Panning



Series: Manufacturing Code: PST07

Drawing 3/8 Scale – For Custom Size Drawing Contact Graham

Note: Sealant Not Shown On Details. Refer To General Installation Instructions.

Delaware Post-Set Panning Head And Jamb		
Description	'A' Dim X 'B' Dim	Slope
Delaware	3.701 X 2.785	–

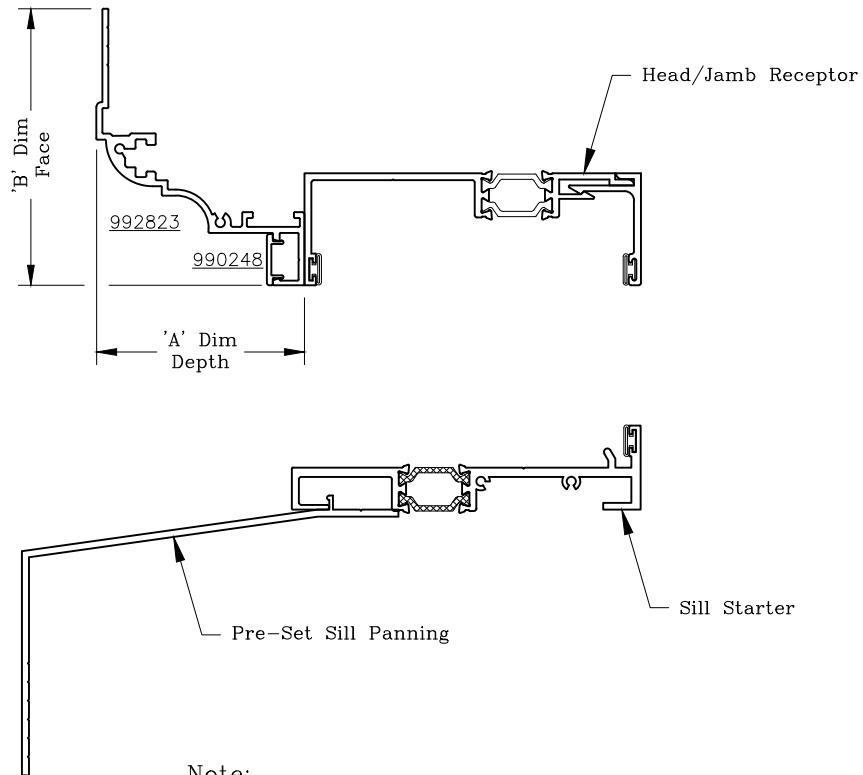

Note:  
Head/Jamb Receptor, Sill Starter And Preset  
Panning Are Shown For Reference Only.