

# #5 Attached Panning Rectangular



Series: Accessories Manufacturing Code: PN01

Drawing 3/8 Scale – For Custom Size Drawing Contact Graham

Note: Sealant Not Shown On Details. Refer To General Installation Instructions.

Note: Pre-Set Panning Requires The Use Of Equal Leg Sill On Window

Attached Panning Head And Jambs			
Description	"A" Dim. x "B" Dim.	Extrusion Die #99	Slope =
#5-1.5	.500 x 1.500	1025	None
#5-2	.500 x 2.000	1035	None
#5-2.5	.500 x 2.500	1045	None
#5-3	.500 x 3.000	1055	None

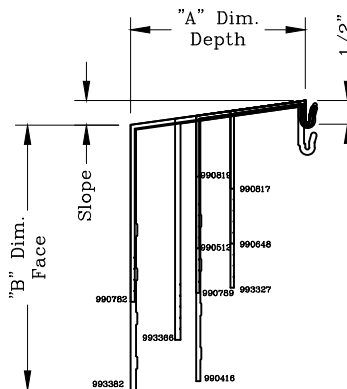
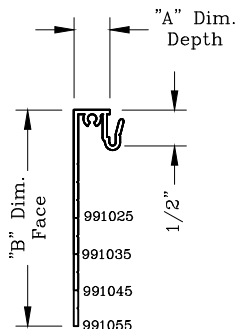
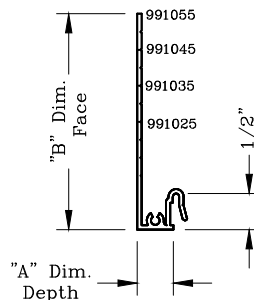

Attached Panning Mating Sill			
Description	"A" Dim. x "B" Dim.	Extrusion Die #99	Slope =
#5-1.5	.500 x 1.500	1025	None
#5-2	.500 x 2.000	1035	None
#5-2.5	.500 x 2.500	1045	None
#5-3	.500 x 3.000	1055	None

Attached Panning Mating Sill			
Description	"A" Dim. x "B" Dim.	Extrusion Die #99	Slope =
#10-2 S	1.698 x 2.000	0817	.239
#10-3 S	1.698 x 3.000	0648	.239
#3-4 BOE	1.698 x 4.000	3327	.239
#3-4	3.956 x 4.000	0782	.556
#3-6	3.956 x 6.000	3382	.556
#8-1.3 S	2.475 x 1.375	0819	.348
#8-3 S	2.475 x 3.000	0512	.348
#8-4 S	2.475 x 4.000	0789	.348
#8-6 S	2.475 x 6.000	0416	.348
DEL BOE-5	2.952 x 5.000	3366	.415

Graham Architectural Products reserves the right to change, add, cancel, remove or otherwise modify the details illustrated without prior notice.

1551 Mt. Rose Avenue, York, Pennsylvania 17403-2909 800/755-6274 Fax: 800/366-5097

1221 – PN.01

Web Site: [www.grahamwindows.com](http://www.grahamwindows.com)

# #10 Attached Panning Rectangular



Series: Accessories Manufacturing Code: PN02

Drawing 3/8 Scale – For Custom Size Drawing Contact Graham

Note: Sealant Not Shown On Details. Refer To General Installation Instructions.

Note: Pre-Set Panning Requires The Use Of Equal Leg Sill On Window

Attached Panning Head And Jambs			
Description	"A" Dim. x "B" Dim.	Extrusion Die #99	Slope =
#10-3-.062	1.683 x 3.000	1221	None
#10-4-.062	1.683 x 4.000	1231	None

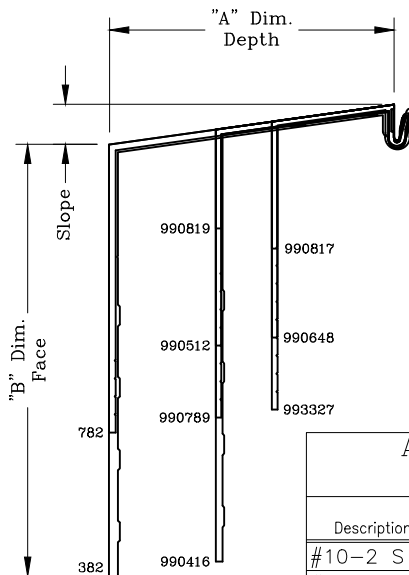
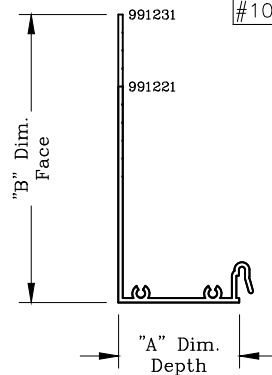

Attached Panning Mating Sill			
Description	"A" Dim. x "B" Dim.	Extrusion Die #99	Slope =
#10-2 S	1.698 x 2.000	0817	.239
#10-3 S	1.698 x 3.000	0648	.239
#10-4 S	1.698 x 4.000	3327	.239
#8-1.3 S	2.475 x 1.375	0819	.348
#8-3 S	2.475 x 3.000	0512	.348
#8-4 S	2.475 x 4.000	0789	.348
#8-6 S	2.475 x 6.000	0416	.348
#3-4 S	3.956 x 4.000	0782	.556
#3-6 S	3.956 x 6.000	3382	.556

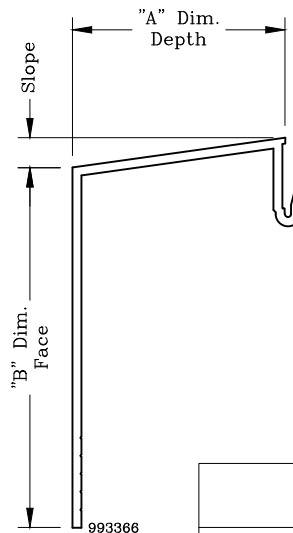

Attached Panning Mating Sill			
Description	"A" Dim. x "B" Dim.	Extrusion Die #99	Slope =
DEL 5 BOE	2.952 x 5.000	3366	.415

Graham Architectural Products reserves the right to change, add, cancel, remove or otherwise modify the details illustrated without prior notice.

1551 Mt. Rose Avenue, York, Pennsylvania 17403-2909 800/755-6274 Fax: 800/366-5097

1221 - PN.02

Web Site: [www.grahamwindows.com](http://www.grahamwindows.com)

# #8 Attached Panning Rectangular



Series: Accessories Manufacturing Code: PN03

Drawing 3/8 Scale – For Custom Size Drawing Contact Graham

Note: Sealant Not Shown On Details. Refer To General Installation Instructions.

Note: Pre-Set Panning Requires The Use Of Equal Leg Sill On Window

Attached Panning Head And Jambs			
Description	"A" Dim. x "B" Dim.	Extrusion Die #99	Slope =
#8-3	2.560 x 3.000	1325	None
#8-4	2.560 x 4.000	1335	None

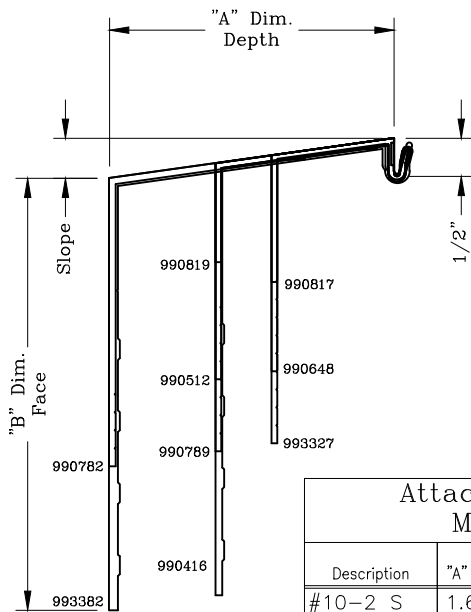
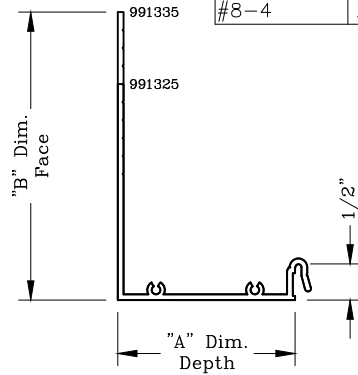

Attached Panning Mating Sill			
Description	"A" Dim. x "B" Dim.	Extrusion Die #99	Slope =
#10-2 S	1.698 x 2.000	0817	.239
#10-3 S	1.698 x 3.000	0648	.239
#3-4 BOE	1.698 x 4.000	3327	.239
#8-1.3 S	2.475 x 1.375	0819	.348
#8-3 S	2.475 x 3.000	0512	.348
#8-4 S	2.475 x 4.000	0789	.348
#8-6 S	2.475 x 6.000	0416	.348
#3-4 S	3.956 x 4.000	0782	.556
#3-6 S	3.956 x 6.000	3382	.556

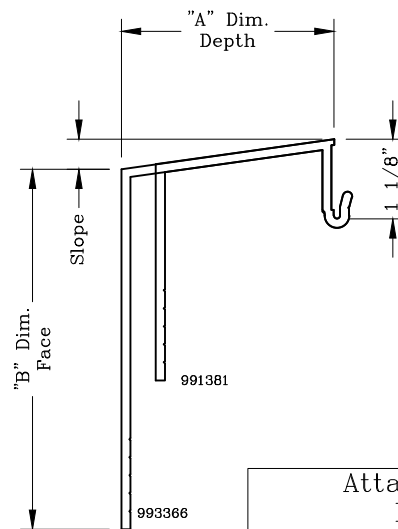

Attached Panning Mating Sill			
Description	"A" Dim. x "B" Dim.	Extrusion Die #99	Slope =
#8-3 BOE	2.475 x 3.000	1381	.348
DEL 5 BOE	2.652 x 3.000	3366	.415

Graham Architectural Products reserves the right to change, add, cancel, remove or otherwise modify the details illustrated without prior notice.

1551 Mt. Rose Avenue, York, Pennsylvania 17403-2909 800/755-6274 Fax: 800/366-5097

1221 - PN.03

Web Site: www.grahamwindows.com

# #3 Attached Panning Rectangular



Series: Accessories Manufacturing Code: PN04

Drawing 3/8 Scale – For Custom Size Drawing Contact Graham

Note: Sealant Not Shown On Details. Refer To General Installation Instructions.

Note: Pre-Set Panning Requires The Use Of Equal Leg Sill On Window

Attached Panning Head And Jamb			
Description	"A" Dim. x "B" Dim.	Extrusion Die #99	Slope =
#3-22	3.941 x 2.250	1410	None
#3-30	3.941 x 3.000	1425	None

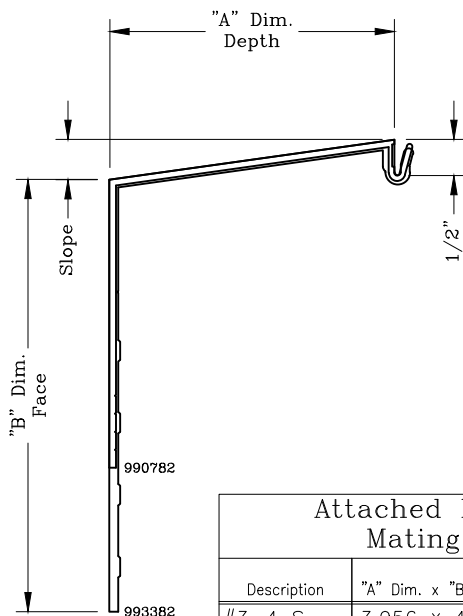
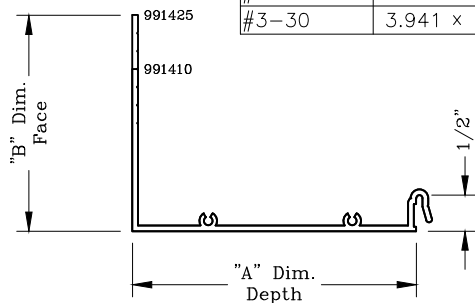

Attached Panning Mating Sill			
Description	"A" Dim. x "B" Dim.	Extrusion Die #99	Slope =
#3-4 S	3.956 x 4.000	0782	.556
#3-6 S	3.956 x 6.000	3382	.556

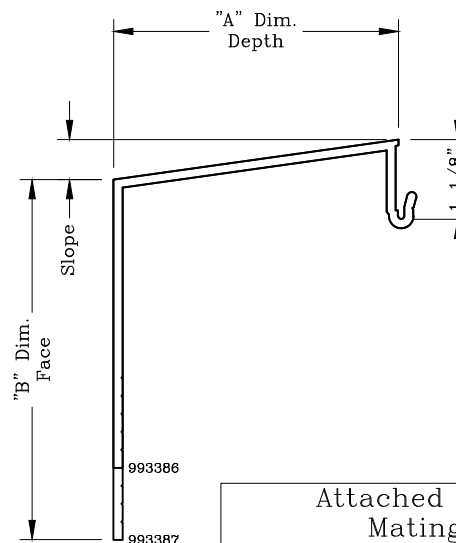

Attached Panning Mating Sill			
Description	"A" Dim. x "B" Dim.	Extrusion Die #99	Slope =
#3-4 BOE	3.956 x 4.000	3386	.556
#3-5 BOE	3.956 x 5.000	3387	.556

Graham Architectural Products reserves the right to change, add, cancel, remove or otherwise modify the details illustrated without prior notice.

1551 Mt. Rose Avenue, York, Pennsylvania 17403-2909 800/755-6274 Fax: 800/366-5097

Web Site: [www.grahamwindows.com](http://www.grahamwindows.com)

0122 - PN.04

# Attached Panning Rectangular



Series: Accessories Manufacturing Code: PN05

Drawing 3/8 Scale – For Custom Size Drawing Contact Graham

Note: Sealant Not Shown On Details. Refer To General Installation Instructions.

Note: Pre-Set Panning Requires The Use Of Equal Leg Sill On Window

William Penn #2 Attached Panning Head And Jambs			
Description	"A" Dim. x "B" Dim.	Extrusion Die #99	Slope =
William Penn 2	3.000 x 2.468	2533	None

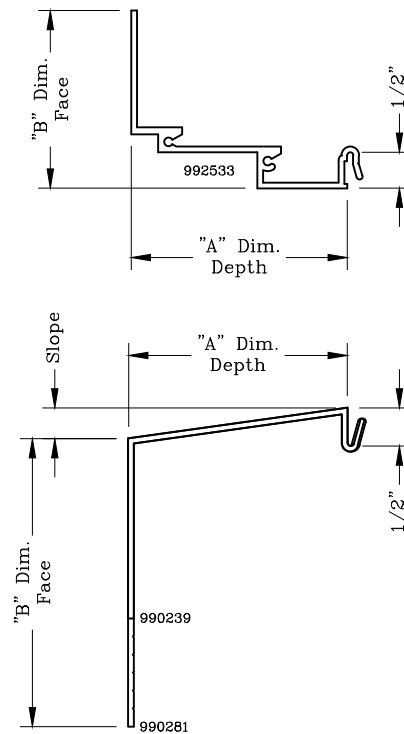

William Penn #2 Attached Panning Mating Sill			
Description	"A" Dim. x "B" Dim.	Extrusion Die #99	Slope =
Del -2.5	3.043 x 2.500	0239	.428
Del -4	3.043 x 4.000	0281	.428

Graham Architectural Products reserves the right to change, add, cancel, remove or otherwise modify the details illustrated without prior notice.

1551 Mt. Rose Avenue, York, Pennsylvania 17403-2909 800/755-6274 Fax: 800/366-5097

Web Site: [www.grahamwindows.com](http://www.grahamwindows.com)

0522 - PN.05

# Attached Panning Angled – 45 Degree



Series: Accessories Manufacturing Code: PN06

Drawing 1/2 Scale – For Custom Size Drawing Contact Graham

Note: Sealant Not Shown On Details. Refer To General Installation Instructions.

Note: Pre-Set Panning Requires The Use Of Equal Leg Sill On Window

45 Degree Attached Panning Head and Jambs			
Description	"A" Dim. x "B" Dim.	Extrusion Die #99	Slope =
#8-1.8	2.000 x 1.813	2525	None

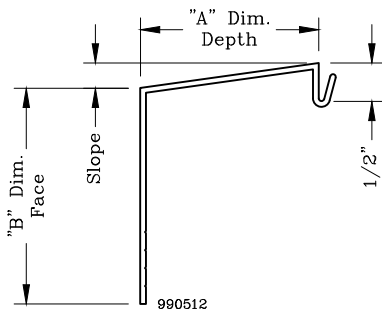
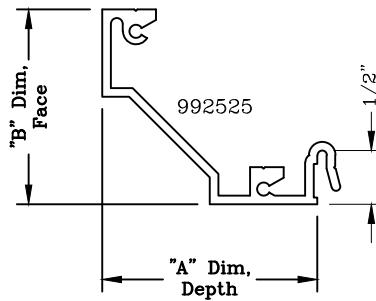

45 Degree Attached Panning Mating Sill			
Description	"A" Dim. x "B" Dim.	Extrusion Die #99	Slope =
#8-3	2.475 x 3.000	0512	.348

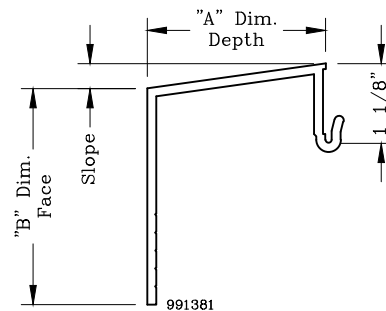

45 Degree Attached Panning Mating Sill			
Description	"A" Dim. x "B" Dim.	Extrusion Die #99	Slope =
#8-3	2.475 x 3.000	1381	.348

Graham Architectural Products reserves the right to change, add, cancel, remove or otherwise modify the details illustrated without prior notice.

1551 Mt. Rose Avenue, York, Pennsylvania 17403-2909 800/755-6274 Fax: 800/366-5097

Web Site: [www.grahamwindows.com](http://www.grahamwindows.com)

0522 – PN.06

# Attached Panning Contoured



Series: Accessories Manufacturing Code: PN07

Drawing 3/8 Scale – For Custom Size Drawing Contact Graham

Note: Sealant Not Shown On Details. Refer To General Installation Instructions.

Note: Pre-Set Panning Requires The Use Of Equal Leg Sill On Window

Fifth Avenue Attached Panning Head And Jamb			
Description	"A" Dim. x "B" Dim.	Extrusion Die #99	"Slope Height"
Fifth Avenue	3.000 x 3.000	2530	None

Cotton Mill Attached Panning Head And Jamb			
Description	"A" Dim. x "B" Dim.	Extrusion Die #99	"Slope Height"
Cotton Mill	1.687 x 3.250	2404	None

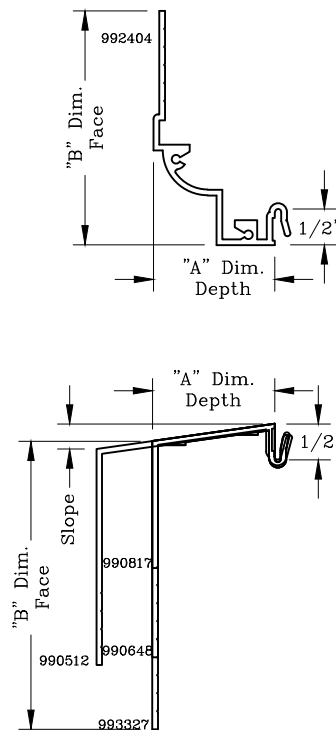
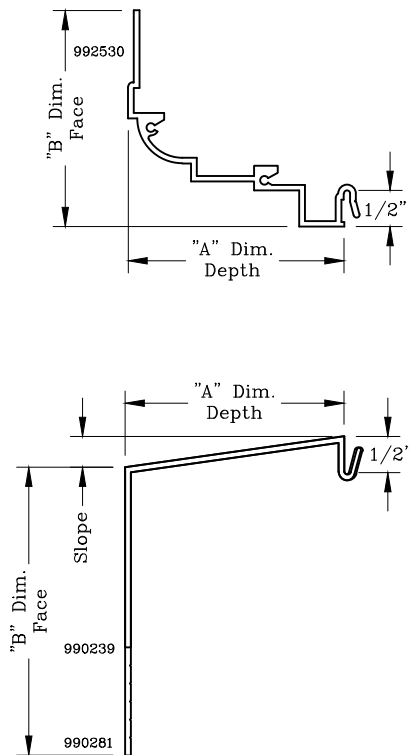

Fifth Avenue Attached Panning Mating Sill			
Description	"A" Dim. x "B" Dim.	Extrusion Die #99	"Slope Height"
Del-3 S	3.000 x 2.500	0239	.428
Del-4 S	3.000 x 4.000	0281	.428

Cotton Mill Attached Panning Mating Sill			
Description	"A" Dim. x "B" Dim.	Extrusion Die #99	"Slope Height"
#10-1.7 S	1.698 x 1.761	0817	.239
#10-3 S	1.698 x 3.000	0648	.239
#10-4 S	1.698 x 4.000	3327	.239
#8-3	2.475 x 3.000	0512	.348

Graham Architectural Products reserves the right to change, add, cancel, remove or otherwise modify the details illustrated without prior notice.

1551 Mt. Rose Avenue, York, Pennsylvania 17403-2909 800/755-6274 Fax: 800/366-5097

Web Site: [www.grahamwindows.com](http://www.grahamwindows.com)

0522 – PN.07

# Attached Panning Contoured



Series: Accessories Manufacturing Code: PN08

Drawing 3/8 Scale – For Custom Size Drawing Contact Graham

Note: Sealant Not Shown On Details. Refer To General Installation Instructions.

Note: Pre-Set Panning Requires The Use Of Equal Leg Sill On Window

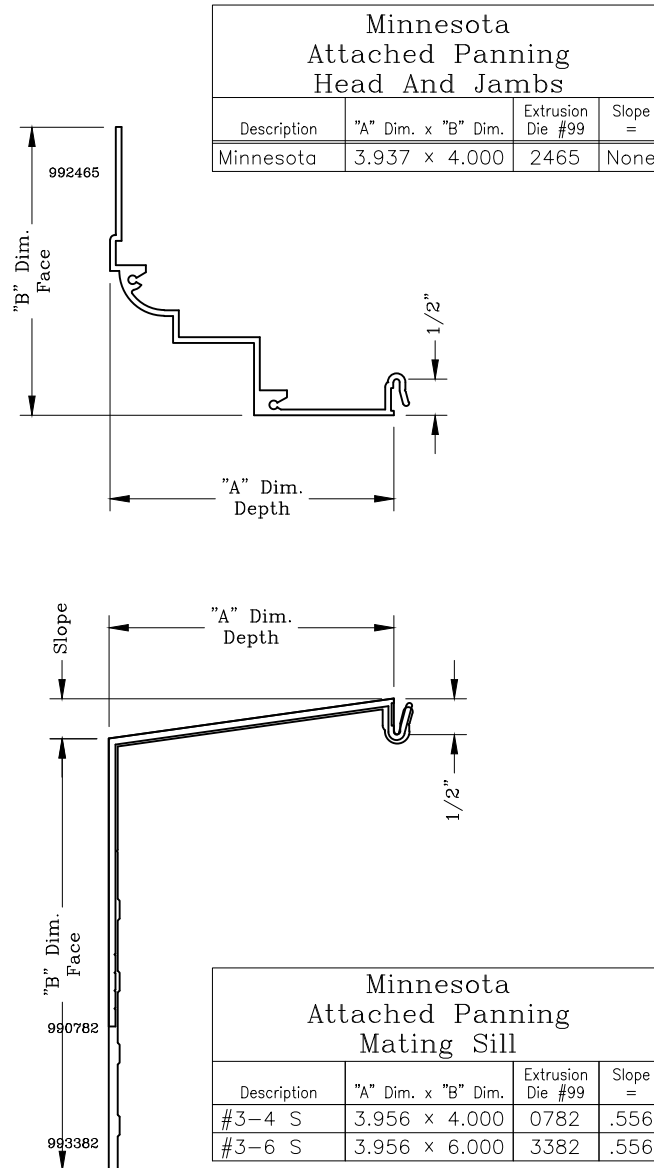



# Attached Panning Contoured



Series: Accessories Manufacturing Code: PN09

Drawing 3/8 Scale – For Custom Size Drawing Contact Graham

Note: Sealant Not Shown On Details. Refer To General Installation Instructions.

Note: Pre-Set Panning Requires The Use Of Equal Leg Sill On Window

Newtown Court Attached Panning Head And Jamb		
Description	"A" Dim. x "B" Dim.	Part Number
Frame Extender	2.188 x 1.231	858645

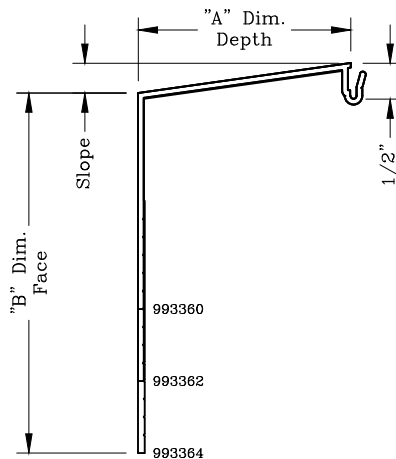
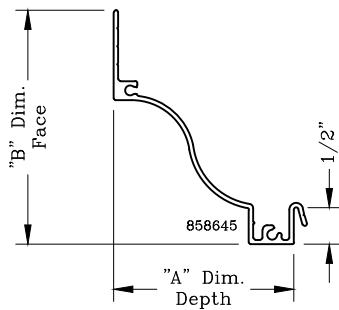

Newtown Court Attached Panning Mating Sill			
Description	"A" Dim. x "B" Dim.	Extrusion Die #99	Slope =
Del-3 S	2.952 x 3.000	3360	.415
Del-4 S	2.952 x 4.000	3362	.415
Del-5 S	2.952 x 5.000	3364	.415

Graham Architectural Products reserves the right to change, add, cancel, remove or otherwise modify the details illustrated without prior notice.

1551 Mt. Rose Avenue, York, Pennsylvania 17403-2909 800/755-6274 Fax: 800/366-5097

Web Site: [www.grahamwindows.com](http://www.grahamwindows.com)

0522 – PN.09

# Attached Panning Contoured



Series: Accessories Manufacturing Code: PN10

Drawing 3/8 Scale – For Custom Size Drawing Contact Graham

Note: Sealant Not Shown On Details. Refer To General Installation Instructions.

Note: Pre-Set Panning Requires The Use Of Equal Leg Sill On Window

Marketway / McKinley Attached Panning Head And Jamb			
Description	"A" Dim. x "B" Dim.	Extrusion Die #99	Slope =
Marketway	3.938 x 3.500	2865	None
McKinley	3.938 x 4.500	2875	None

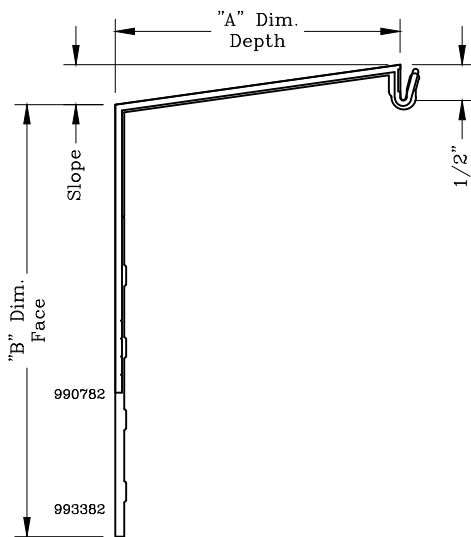
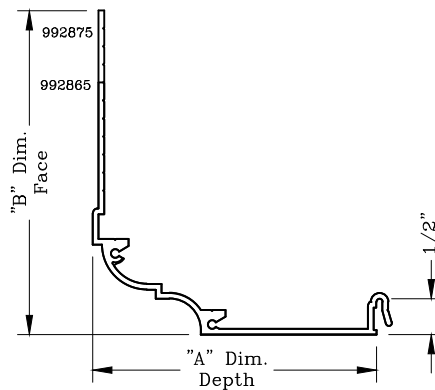

McKinley / Marketway Attached Panning Mating Sill			
Description	"A" Dim. x "B" Dim.	Extrusion Die #99	Slope =
#3-4 S	3.956 x 4.000	0782	.556
#3-6 S	3.956 x 6.000	3382	.556

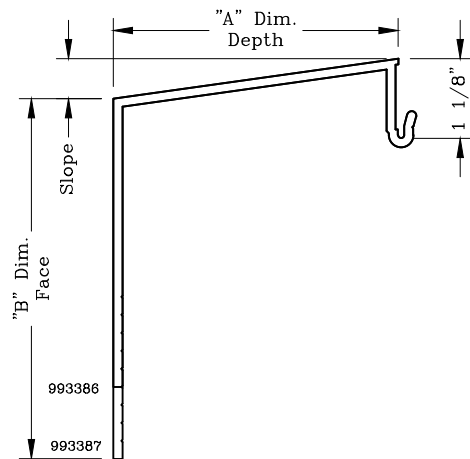

McKinley / Marketway Attached Panning Mating Sill			
Description	"A" Dim. x "B" Dim.	Extrusion Die #99	Slope =
#3-4 BOE	3.956 x 4.000	3386	.556
#3-6 BOE	3.956 x 6.000	3387	.556

Graham Architectural Products reserves the right to change, add, cancel, remove or otherwise modify the details illustrated without prior notice.

1551 Mt. Rose Avenue, York, Pennsylvania 17403-2909 800/755-6274 Fax: 800/366-5097

Web Site: [www.grahamwindows.com](http://www.grahamwindows.com)

0522 - PN.10

# Attached Panning Contoured



Series: Accessories Manufacturing Code: PN11

Drawing 3/8 Scale – For Custom Size Drawing Contact Graham

Note: Sealant Not Shown On Details. Refer To General Installation Instructions.

Note: Pre-Set Panning Requires The Use Of Equal Leg Sill On Window

Delaware / Boylan Attached Panning Head And Jambs			
Description	"A" Dim. x "B" Dim.	Extrusion Die #99	Slope =
Delaware	2.938 x 3.000	2822	None
Boylan	2.938 x 4.750	2835	None

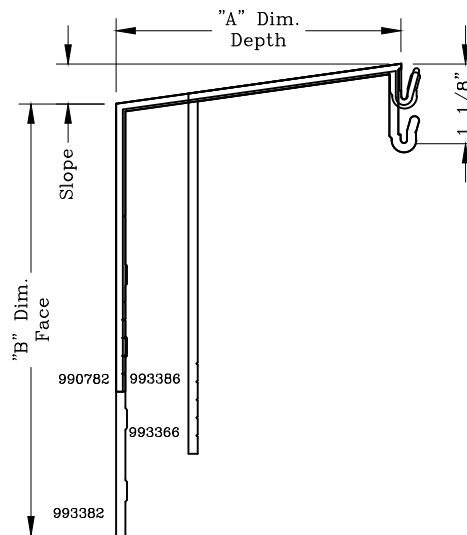
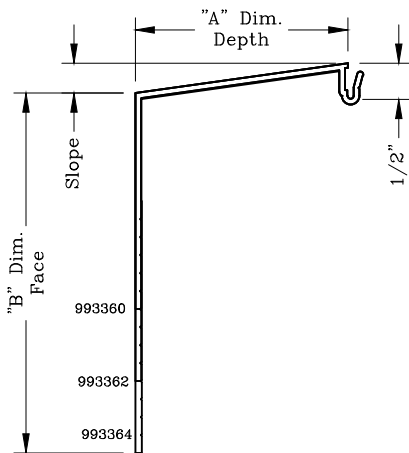
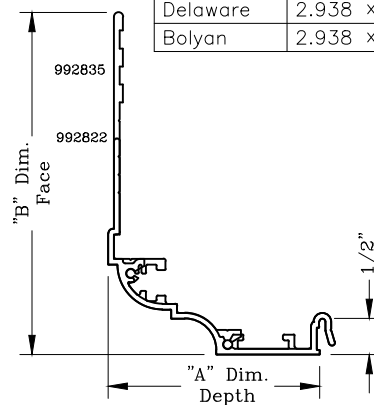

Delaware / Boylan Attached Panning Mating Sill			
Description	"A" Dim. x "B" Dim.	Extrusion Die #99	Slope =
Del-3 S	2.952 x 3.000	3360	.415
Del-4 S	2.952 x 4.000	3362	.415
Del-5 S	2.952 x 5.000	3364	.415

Delaware / Boylan Attached Panning Mating Sill			
Description	"A" Dim. x "B" Dim.	Extrusion Die #99	Slope =
Del 4 BOE	3.956 x 4.000	3386	.556
Del 5 BOE	2.952 x 5.000	3366	.415
#3-4 S	3.956 x 4.000	0782	.556
#3-6 S	3.956 x 6.000	3382	.556

Graham Architectural Products reserves the right to change, add, cancel, remove or otherwise modify the details illustrated without prior notice.

1551 Mt. Rose Avenue, York, Pennsylvania 17403-2909 800/755-6274 Fax: 800/366-5097

Web Site: [www.grahamwindows.com](http://www.grahamwindows.com)

0622 – PN.11

# Attached Panning Contoured



Series: Accessories Manufacturing Code: PN12

Drawing 3/8 Scale – For Custom Size Drawing Contact Graham

Note: Sealant Not Shown On Details. Refer To General Installation Instructions.

Note: Pre-Set Panning Requires The Use Of Equal Leg Sill On Window

Roosevelt Attached Panning Head And Jamb			
Description	"A" Dim. x "B" Dim.	Extrusion Die #99	Slope =
Roosevelt	2.938 x 3.500	2628	None

Delano Attached Panning Head And Jamb			
Description	"A" Dim. x "B" Dim.	Extrusion Die #99	Slope =
Delano	3.938 x 4.000	2650	None

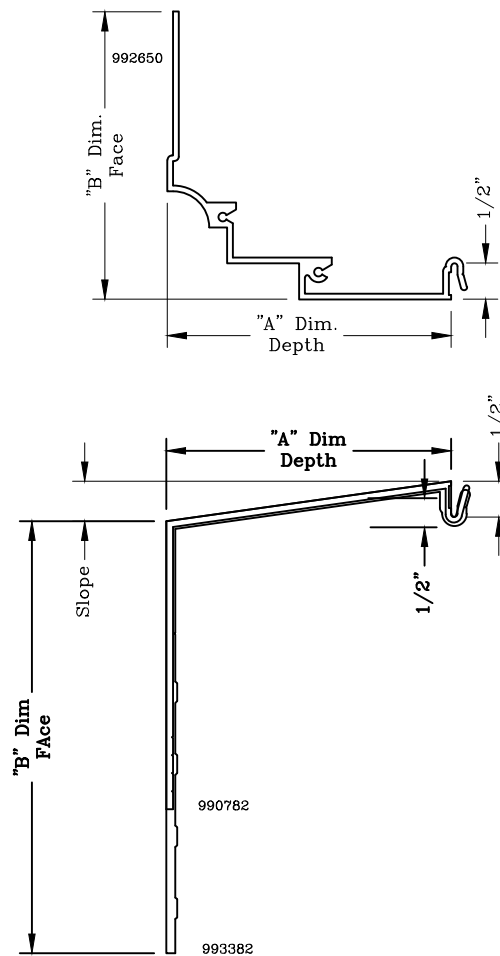
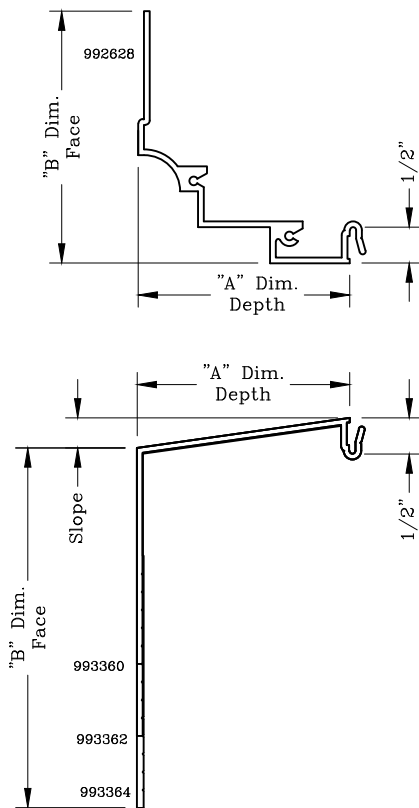

Roosevelt Attached Panning Mating Sill			
Description	"A" Dim. x "B" Dim.	Extrusion Die #99	Slope =
Del-3 S	2.952 x 3.000	3360	.415
Del-4 S	2.952 x 4.000	3362	.415
Del-5 S	2.952 x 5.000	3364	.415

Delano Attached Panning Mating Sill			
Description	"A" Dim. x "B" Dim.	Extrusion Die #99	Slope =
3-4	3.956 x 4.000	0782	.556
3-6	3.956 x 6.000	3382	.556

Graham Architectural Products reserves the right to change, add, cancel, remove or otherwise modify the details illustrated without prior notice.

1551 Mt. Rose Avenue, York, Pennsylvania 17403-2909 800/755-6274 Fax: 800/366-5097

Web Site: [www.grahamwindows.com](http://www.grahamwindows.com)

0522 – PN.12

# Attached Panning Contoured



Series: Accessories Manufacturing Code: PN16

Drawing 1/2 Scale – For Custom Size Drawing Contact Graham

Note: Sealant Not Shown On Details. Refer To General Installation Instructions.

Note: Pre-Set Panning Requires The Use Of Equal Leg Sill On Window

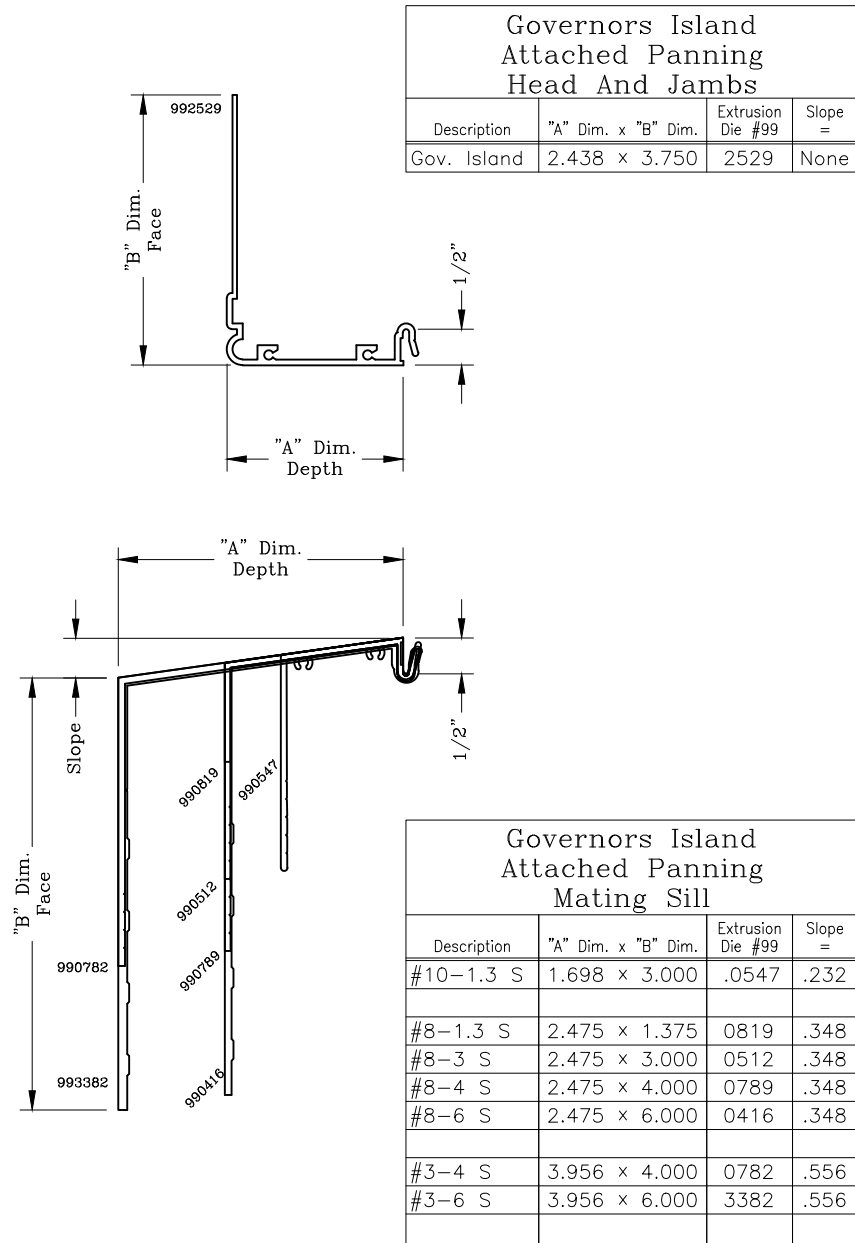

Graham Architectural Products reserves the right to change, add, cancel, remove or otherwise modify the details illustrated without prior notice.

1551 Mt. Rose Avenue, York, Pennsylvania 17403-2909 800/755-6274 Fax: 800/366-5097

Web Site: [www.grahamwindows.com](http://www.grahamwindows.com)

0522 – PN.16

# Attached Panning Contoured



Series: Accessories Manufacturing Code: PN17

Drawing 3/8 Scale – For Custom Size Drawing Contact Graham

Note: Sealant Not Shown On Details. Refer To General Installation Instructions.

Note: Pre-Set Panning Requires The Use Of Equal Leg Sill On Window

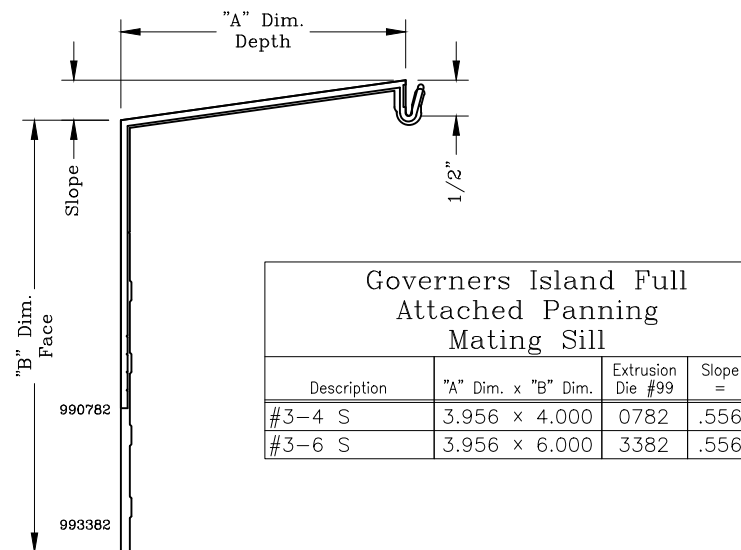
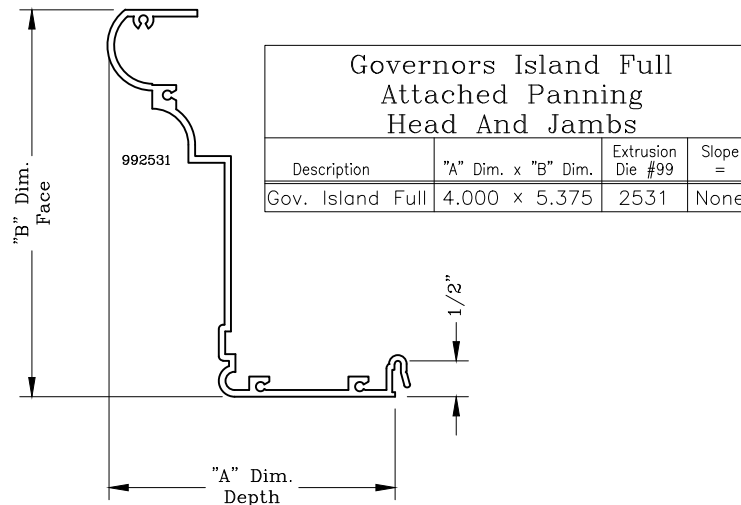

Graham Architectural Products reserves the right to change, add, cancel, remove or otherwise modify the details illustrated without prior notice.

1551 Mt. Rose Avenue, York, Pennsylvania 17403-2909 800/755-6274 Fax: 800/366-5097

Web Site: [www.grahamwindows.com](http://www.grahamwindows.com)

0522 – PN.17

# Attached Panning Frame Extenders



Series: Accessories Manufacturing Code: PN19

Drawing 3/8 Scale – For Custom Size Drawing Contact Graham

Note: Sealant Not Shown On Details. Refer To General Installation Instructions.

Note: Pre-Set Panning Requires The Use Of Equal Leg Sill On Window

In Line Attached Panning Head, Sill And Jamb		
Description	"A" Dim. x "B" Dim.	Part Number
In Line	.241 x 1.691	240102

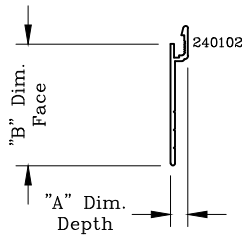

Frame Extender Head, Sill And Jamb		
Description	"A" Dim. x "B" Dim.	Part Number
Frame Extender	2.188 x 1.231	999853

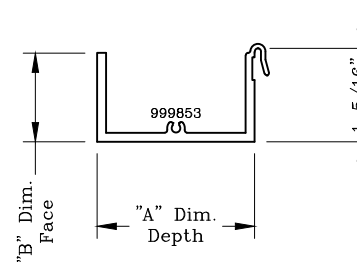

Frame Extender Head, Sill And Jamb		
Description	"A" Dim. x "B" Dim.	Part Number
Frame Extender	1.250 x 2.781	650901

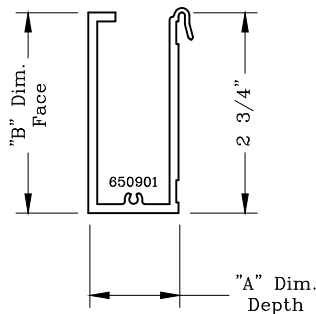

Frame Extender Head, Sill And Jamb		
Description	"A" Dim. x "B" Dim.	Part Number
Frame Extender	1.250 x 1.231	650899

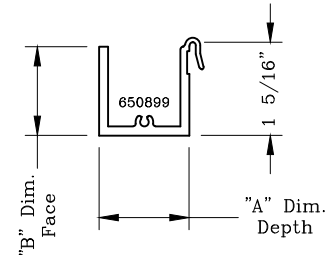

Graham Architectural Products reserves the right to change, add, cancel, remove or otherwise modify the details illustrated without prior notice.

1551 Mt. Rose Avenue, York, Pennsylvania 17403-2909 800/755-6274 Fax: 800/366-5097

Web Site: [www.grahamwindows.com](http://www.grahamwindows.com)

0522 – PN.19