

Horizontal Slider – 4” 1” IG Historical Glazing



Series: GT0200 Manufacturing Code: GT0205

Drawing 1/2 Scale – For Custom Size Drawing Contact Graham

Note: Sealant Not Shown On Details. Refer To General Installation Instructions.

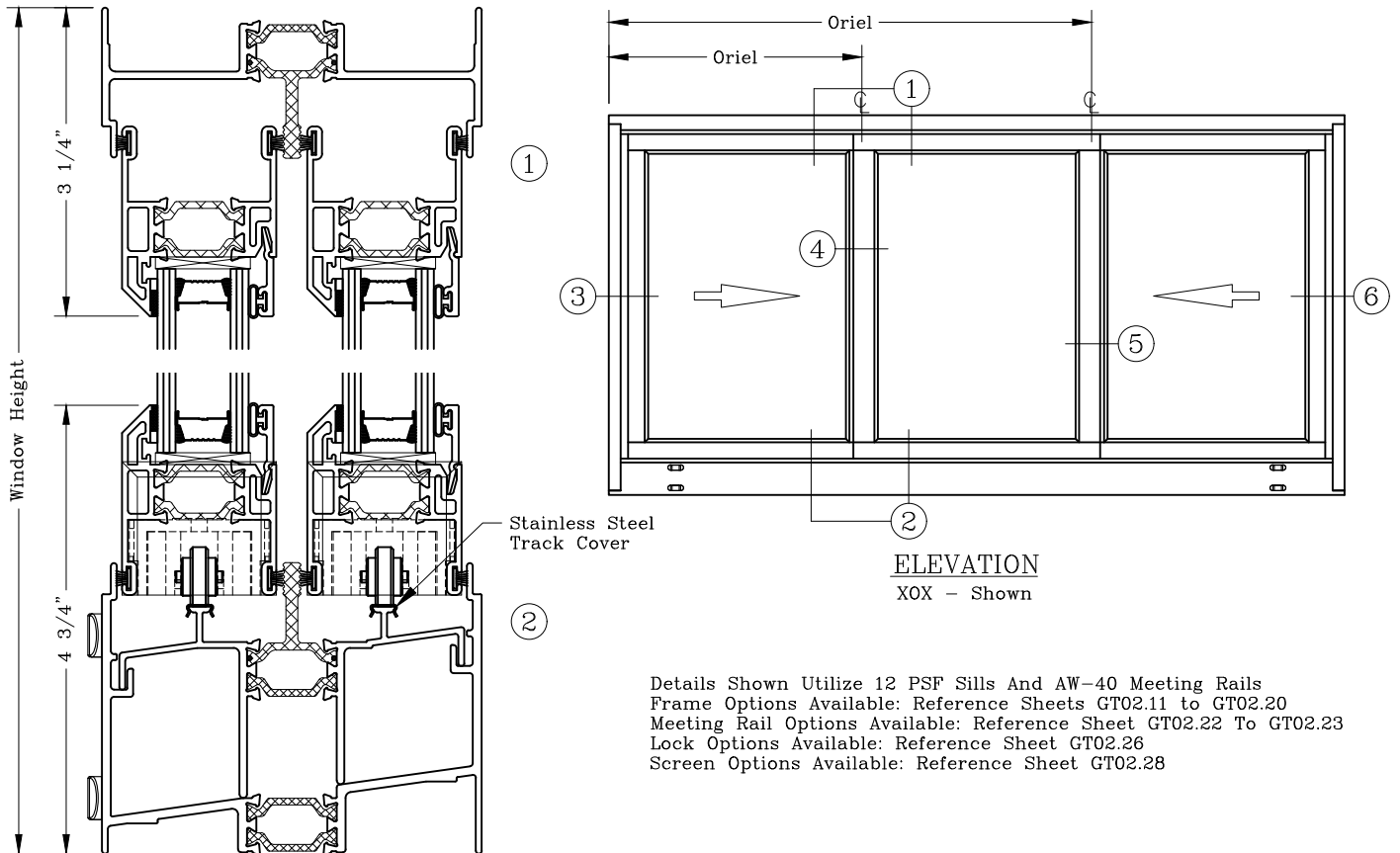

Details Shown Utilize 12 PSF Sills And AW-40 Meeting Rails
 Frame Options Available: Reference Sheets GT02.11 to GT02.20
 Meeting Rail Options Available: Reference Sheet GT02.22 To GT02.23
 Lock Options Available: Reference Sheet GT02.26
 Screen Options Available: Reference Sheet GT02.28

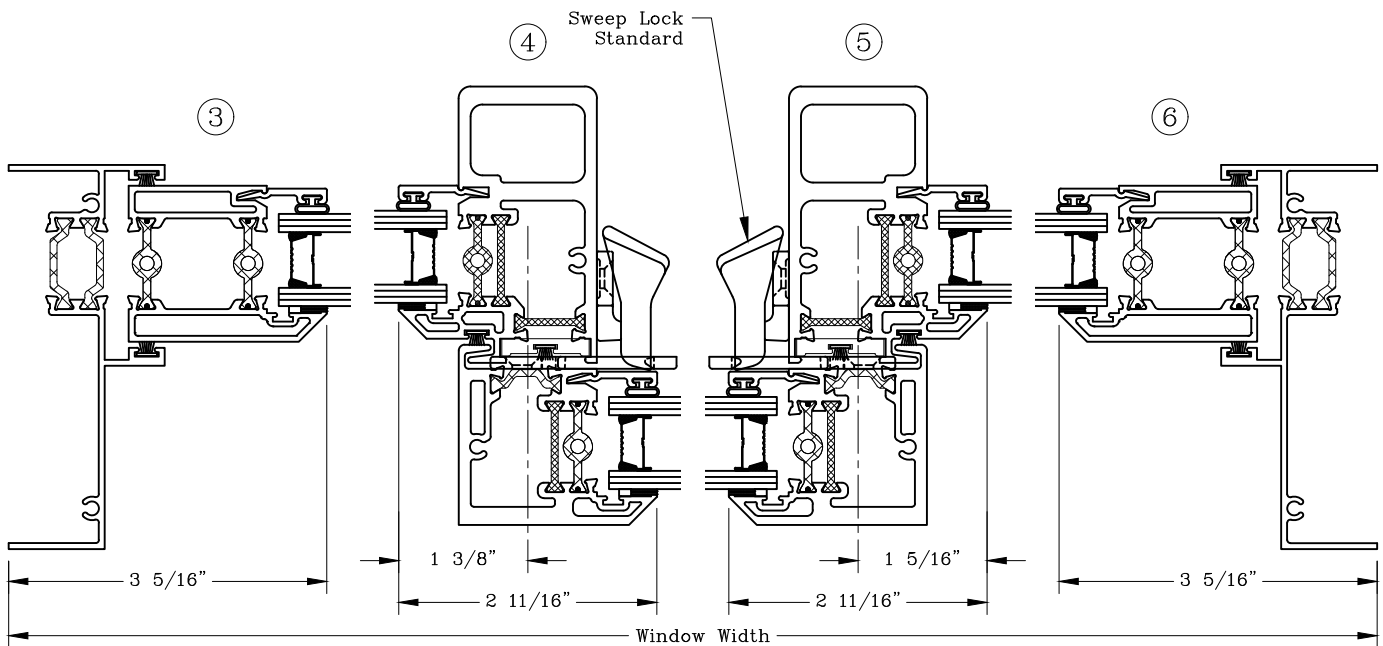

Graham Architectural Products reserves the right to change, add, cancel, remove or otherwise modify the details illustrated without prior notice.

1551 Mt. Rose Avenue, York, Pennsylvania 17403-2909 800/755-6274 Fax: 800/366-5097

1019 – GT02.05

Web Site: www.grahamwindows.com