

Sliding Glass Door - 4"



Series: GT0900

Manufacturing Code: GT0901

Drawing 1/2 Scale - For Custom Size Drawing Contact Graham

Note: Sealant Not Shown On Details. Refer To General Installation Instructions.

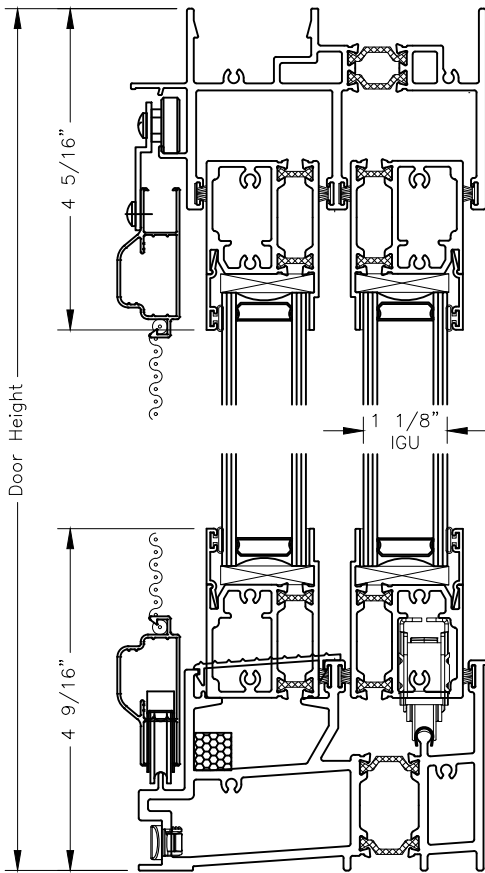

①

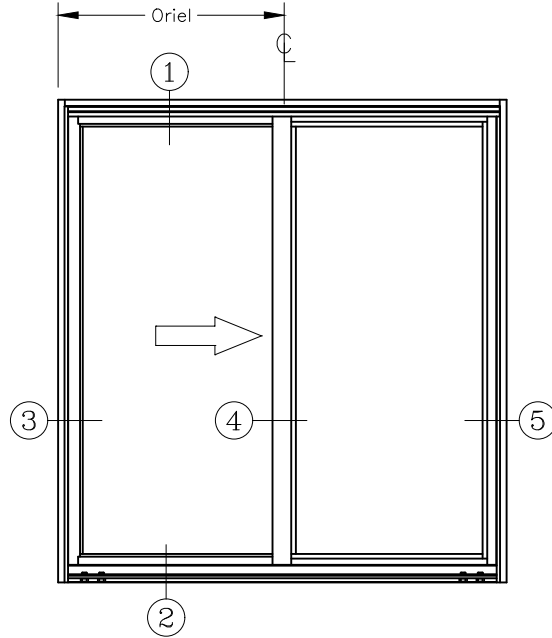

ELEVATION

X0 - Shown
OX - Opposite

Note:
Pull Hardware Default Color Is Black.

②

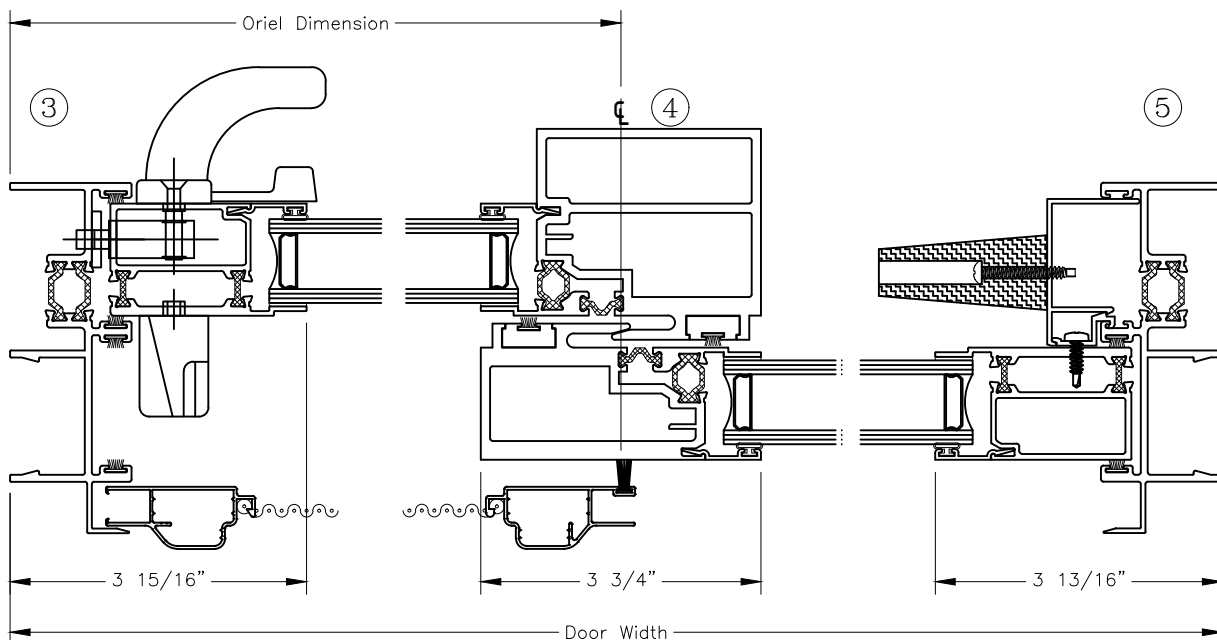

Graham Architectural Products reserves the right to change, add, cancel, remove or otherwise modify the details illustrated without prior notice.

1551 Mt. Rose Avenue, York, Pennsylvania 17403-2909 717.849.8100 Toll Free: 800/755-6274

0524 - GT09.01

Web Site: www.grahamwindows.com

Sliding Glass Door - 4"



Series: GT0900

Manufacturing Code: GT0902

Drawing 1/2 Scale - For Custom Size Drawing Contact Graham

Note: Sealant Not Shown On Details. Refer To General Installation Instructions.

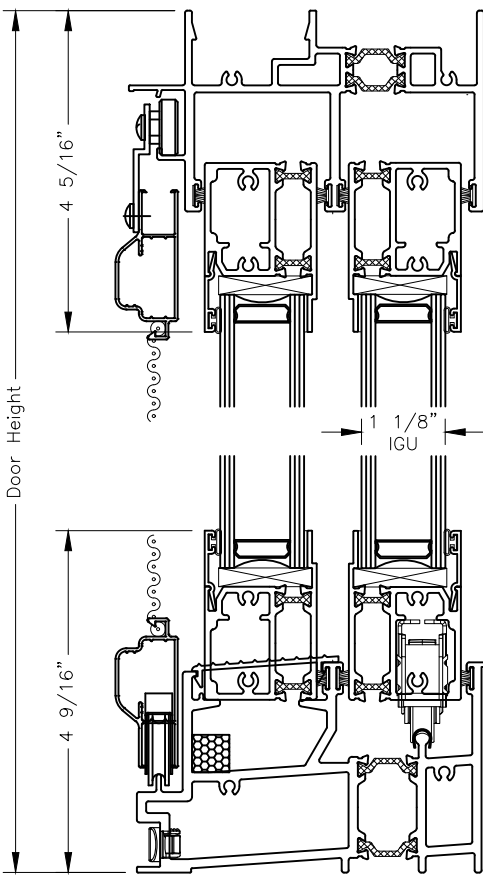

①

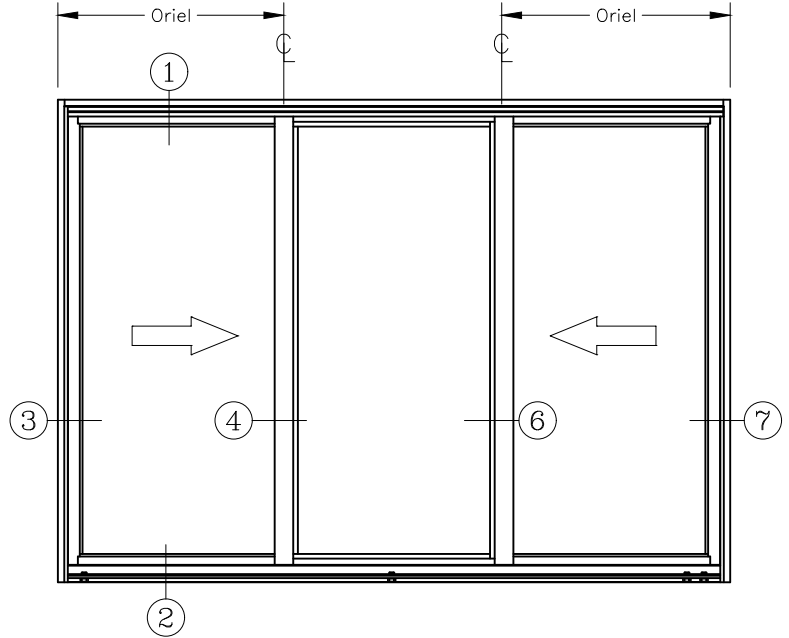

ELEVATION

XOX - Shown

Note:

1. Reference Page GT09.01 For Detail #3
2. Pull Hardware Default Color Is Black.

②

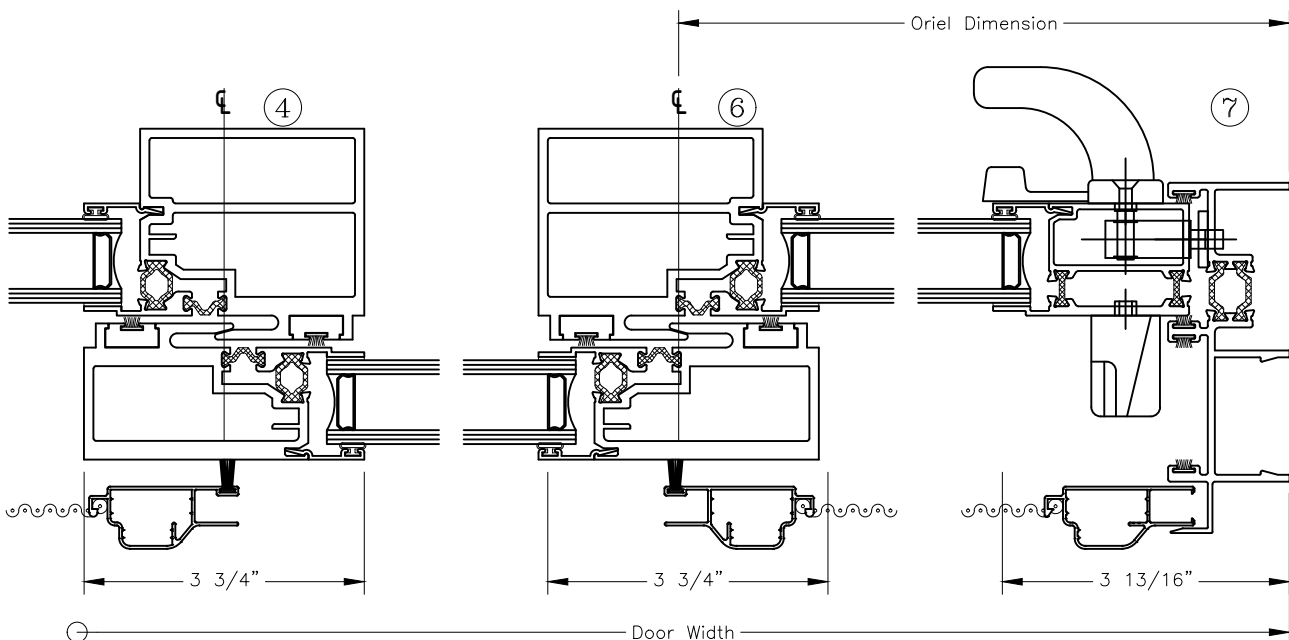

Graham Architectural Products reserves the right to change, add, cancel, remove or otherwise modify the details illustrated without prior notice.

1551 Mt. Rose Avenue, York, Pennsylvania 17403-2909 717.849.8100 Toll Free: 800/755-6274

0524 - GT09.02

Web Site: www.grahamwindows.com

Sliding Glass Door - 4"



Series: GT0900

Manufacturing Code: GT0903

Drawing 1/2 Scale - For Custom Size Drawing Contact Graham

Note: Sealant Not Shown On Details. Refer To General Installation Instructions.

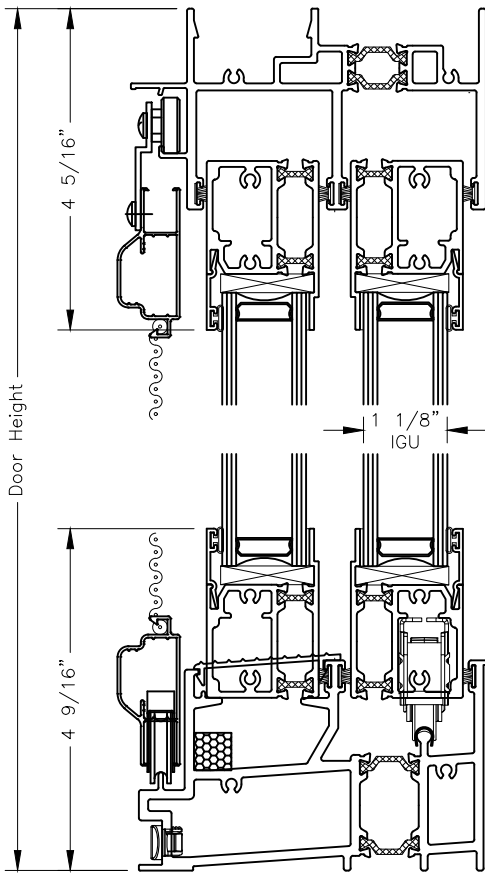

①

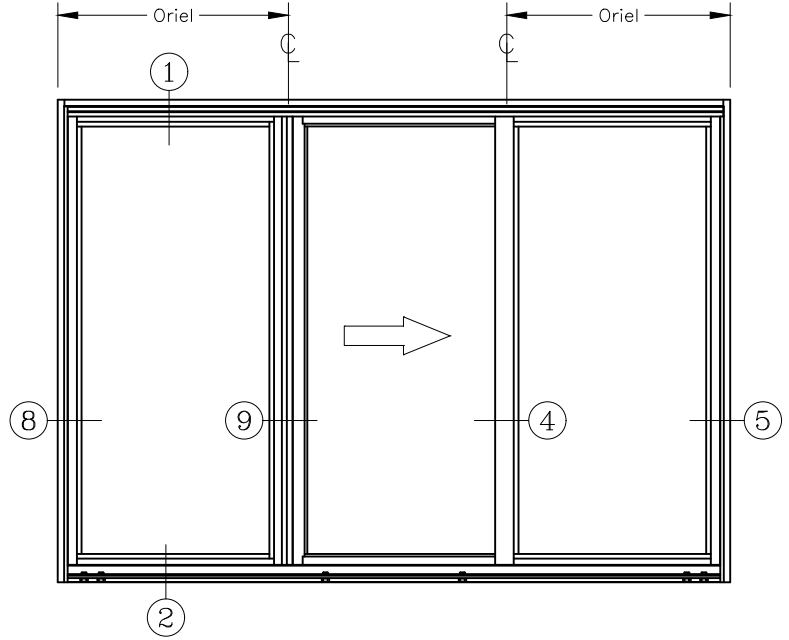

ELEVATION
XOX - Shown

Note:

1. Reference Page GT09.01 For Detail #5
2. Pull Hardware Default Color Is Black.

②

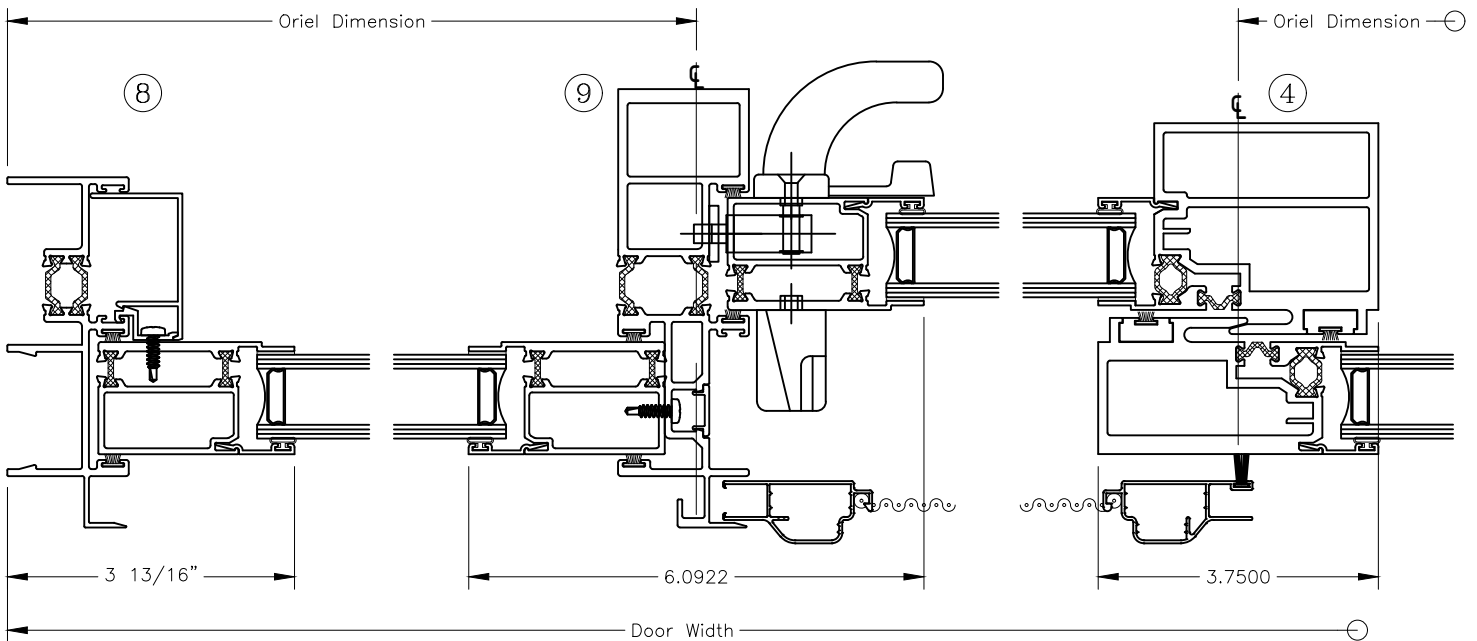

Graham Architectural Products reserves the right to change, add, cancel, remove or otherwise modify the details illustrated without prior notice.

1551 Mt. Rose Avenue, York, Pennsylvania 17403-2909 717.849.8100 Toll Free: 800/755-6274

0524 - GT09.03

Web Site: www.grahamwindows.com

Sliding Glass Door - 4"



Series: GT0900

Manufacturing Code: GT0904

Drawing 1/2 Scale - For Custom Size Drawing Contact Graham

Note: Sealant Not Shown On Details. Refer To General Installation Instructions.

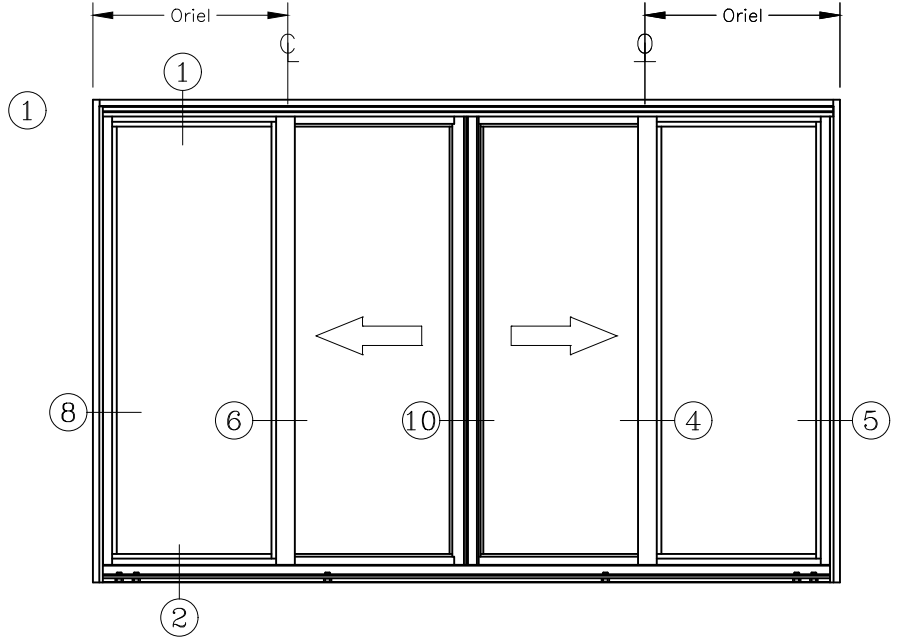
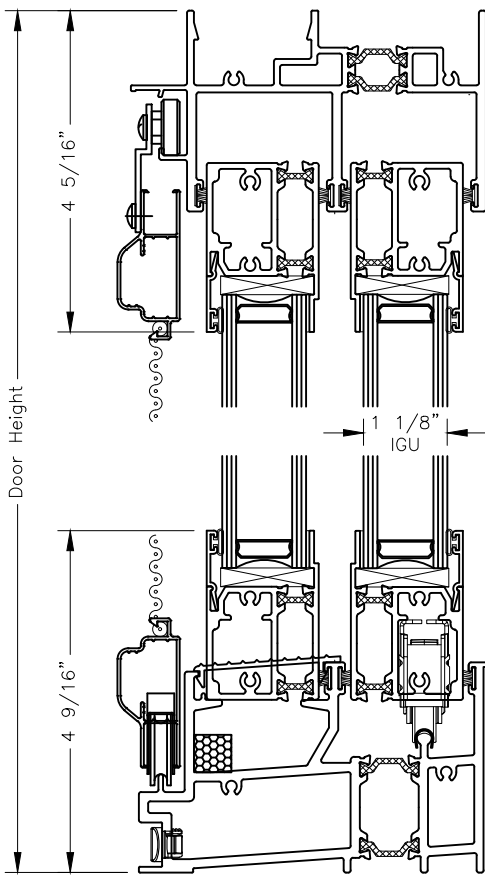

ELEVATION
OXXO - Shown

Note:

1. Reference Page GT09.01 For Details #5
2. Reference Page GT.03 for Detail #8
3. Pull Hardware Default Color Is Black.

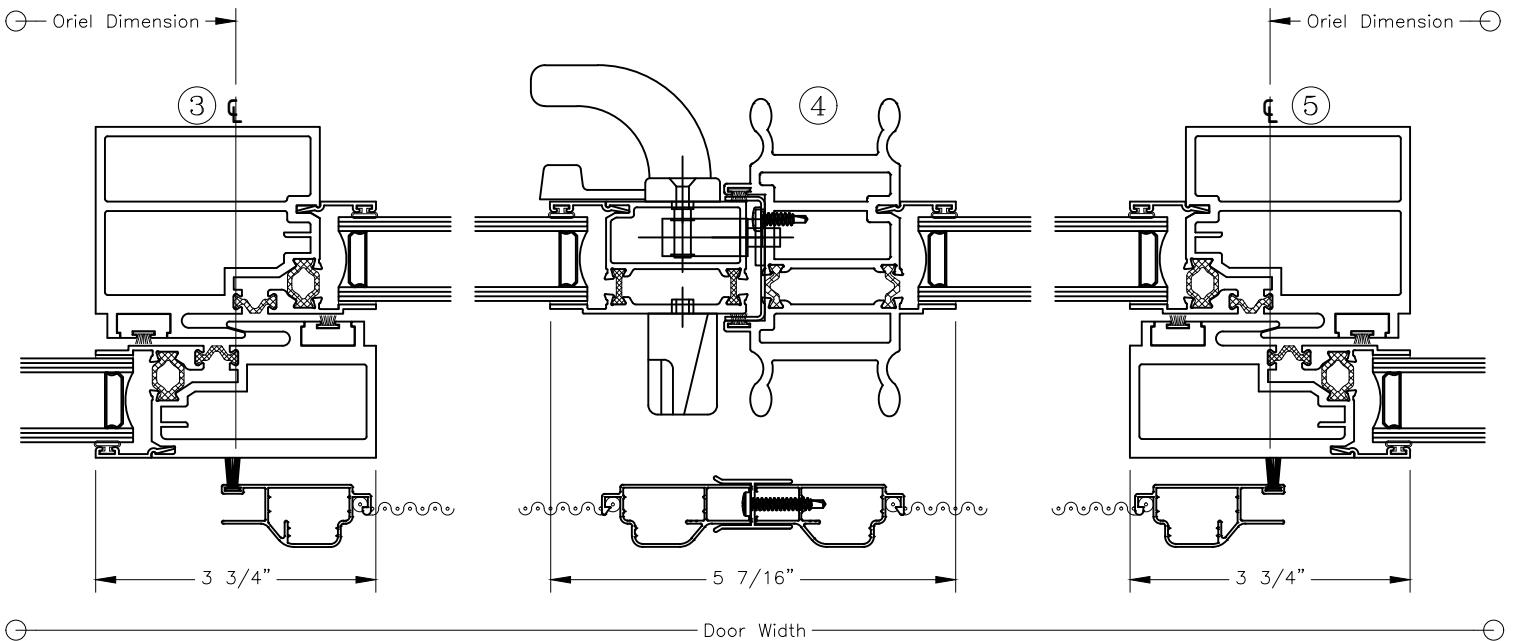

Graham Architectural Products reserves the right to change, add, cancel, remove or otherwise modify the details illustrated without prior notice.

1551 Mt. Rose Avenue, York, Pennsylvania 17403-2909 717.849.8100 Toll Free: 800/755-6274

Web Site: www.grahamwindows.com

0524 - GT09.04

Sliding Glass Door - 4" Interlock Options



Series: GT0900 Manufacturing Code: GT0911

Drawing 1/2 Scale - For Custom Size Drawing Contact Graham

Note: Sealant Not Shown On Details. Refer To General Installation Instructions.

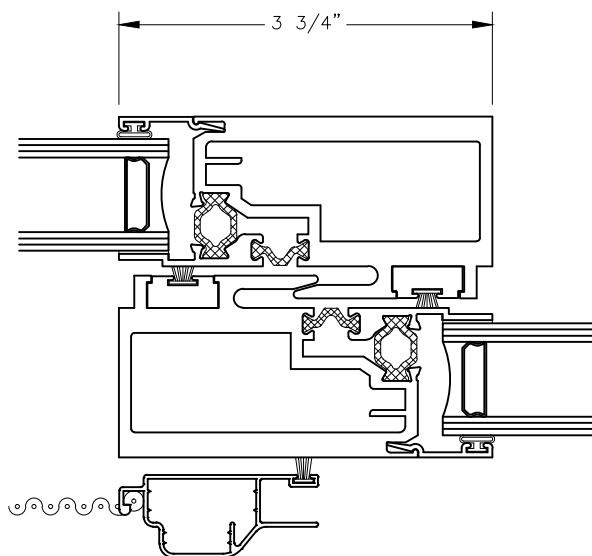

CW (Commercial Window)

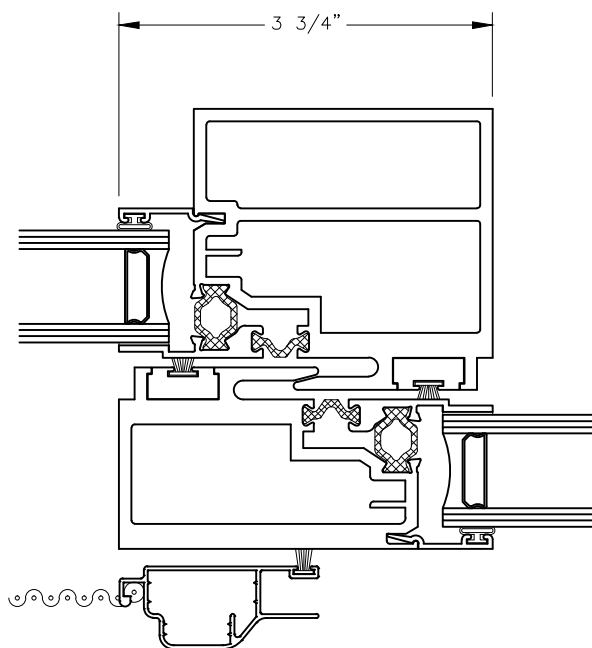

AW-40 (Architectural Window)

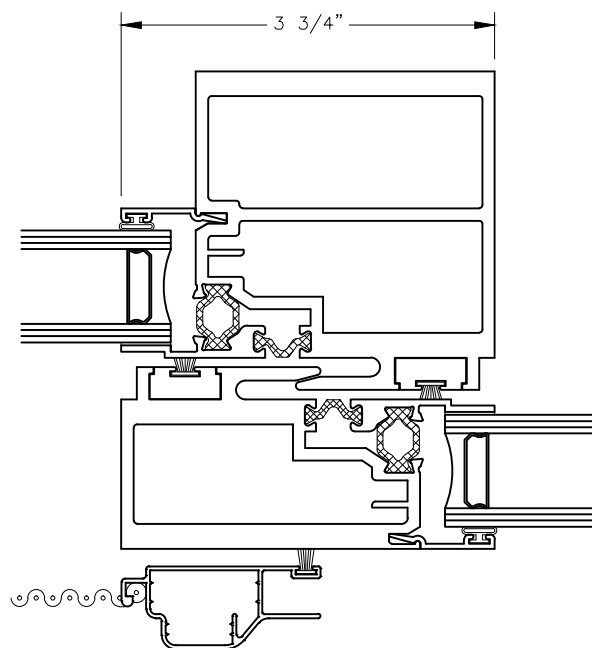

AW-80 (Architectural Window)

Graham Architectural Products reserves the right to change, add, cancel, remove or otherwise modify the details illustrated without prior notice.

1551 Mt. Rose Avenue, York, Pennsylvania 17403-2909 717.849.8100 Toll Free: 800/755-6274

0824 - GT09.11

Web Site: www.grahamwindows.com