

Mullcovers Self Stacking/Base and Covers



Series: Accessories Manufacturing Code: MC01

Drawing 1/2 Scale – For Custom Size Drawing Contact Graham

Note: Sealant Not Shown On Details. Refer To General Installation Instructions.

SELF STACKING MULLIONS FOR EURO ACCESSORY TRACK

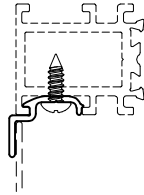

850289
Female Adapter

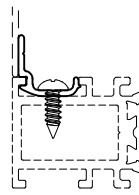

851290
Male Adapter

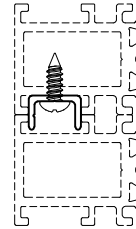

857202
"U" Stack Mullion



MULLION BASES & COVERS

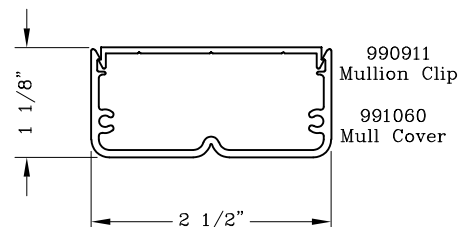
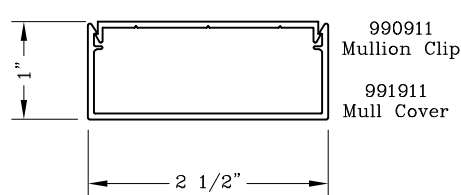
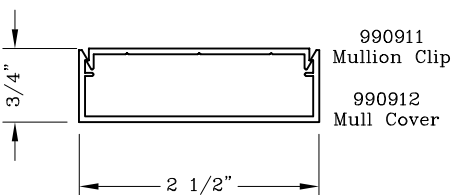
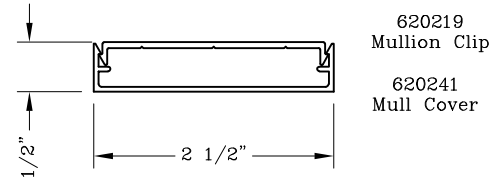
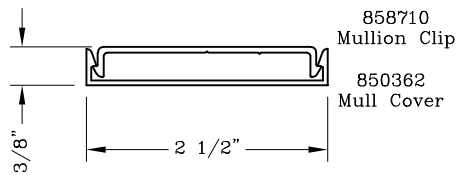
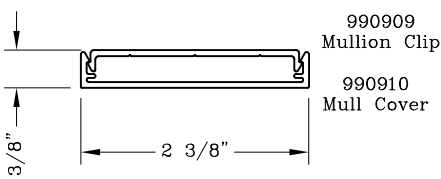
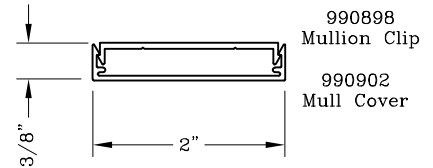
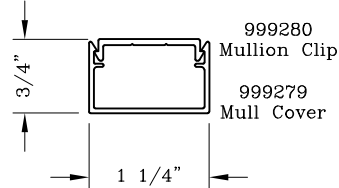
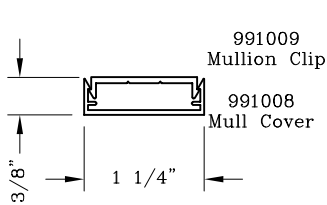

Graham Architectural Products reserves the right to change, add, cancel, remove or otherwise modify the details illustrated without prior notice.

1551 Mt. Rose Avenue, York, Pennsylvania 17403-2909 717.849.8100 Toll Free: 800/755-6274 0223 - MC.01

Web Site: www.grahamwindows.com

Mullcovers



Series: Accessories Manufacturing Code: MC03

Drawing 1/2 Scale – For Custom Size Drawing Contact Graham

Note: Sealant Not Shown On Details. Refer To General Installation Instructions.

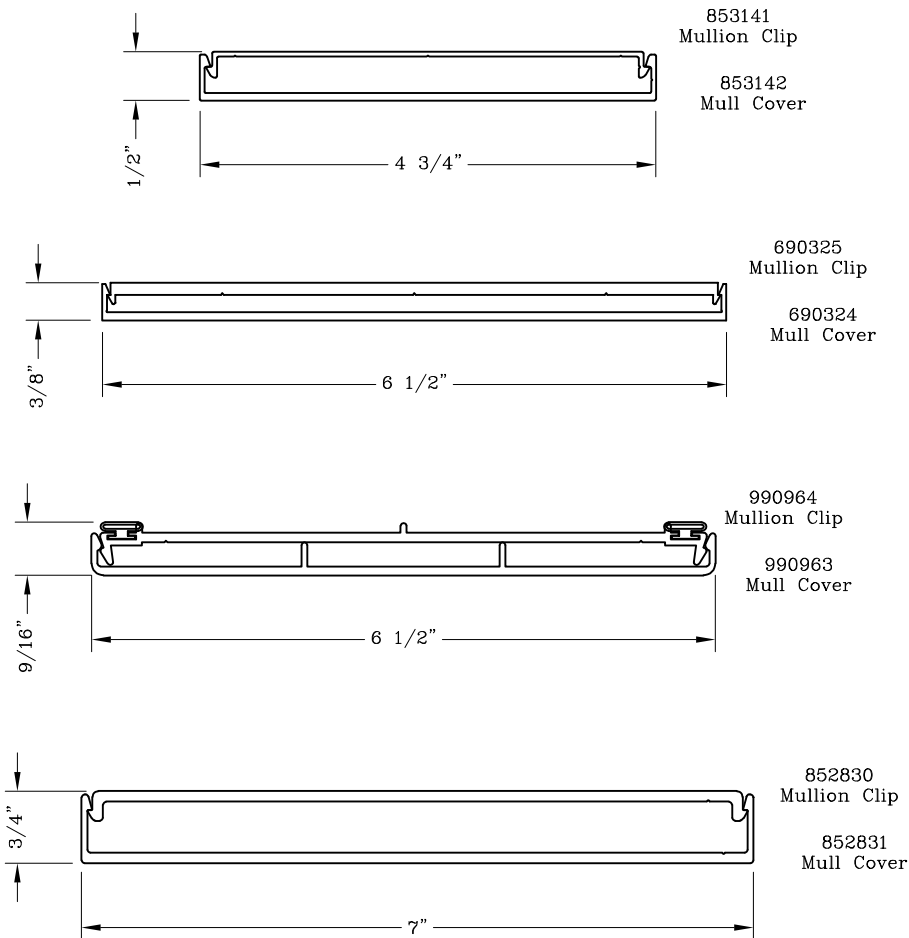

Mullcovers



Series: Accessories Manufacturing Code: MC04

Drawing 1/2 Scale – For Custom Size Drawing Contact Graham

Note: Sealant Not Shown On Details. Refer To General Installation Instructions.

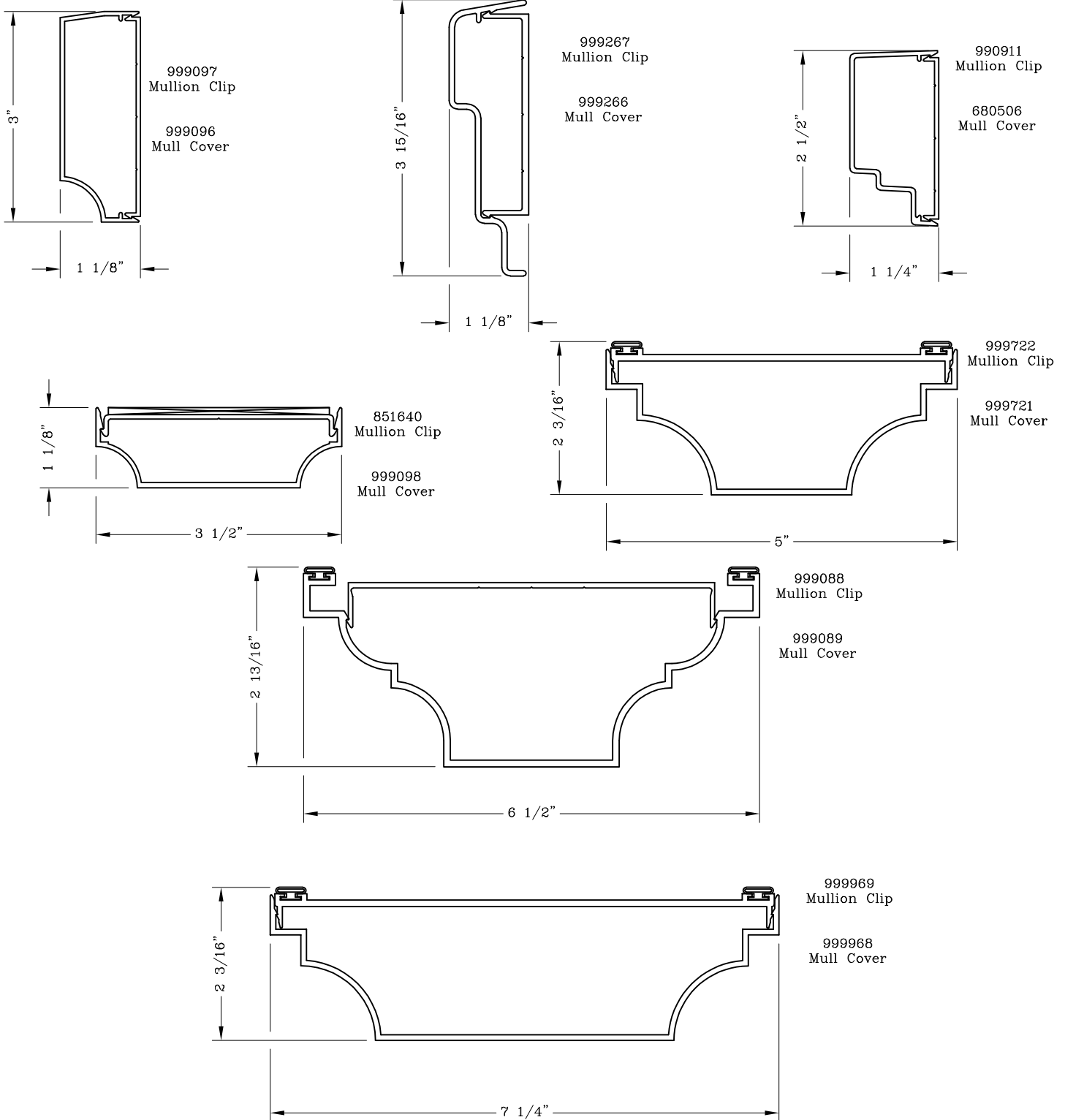

Graham Architectural Products reserves the right to change, add, cancel, remove or otherwise modify the details illustrated without prior notice.

1551 Mt. Rose Avenue, York, Pennsylvania 17403-2909 717.849.8100 Toll Free: 800/755-6274

0223 – MC04

Web Site: www.grahamwindows.com

Mullcovers



Series: Accessories Manufacturing Code: MC05

Drawing 1/2 Scale - For Custom Size Drawing Contact Graham

Note: Sealant Not Shown On Details. Refer To General Installation Instructions.

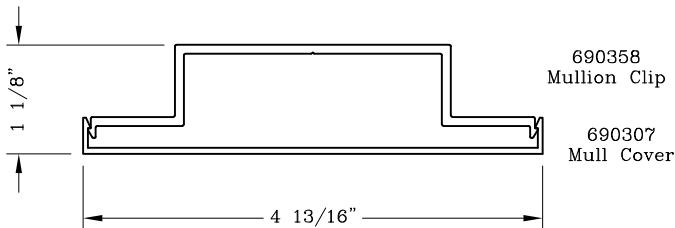
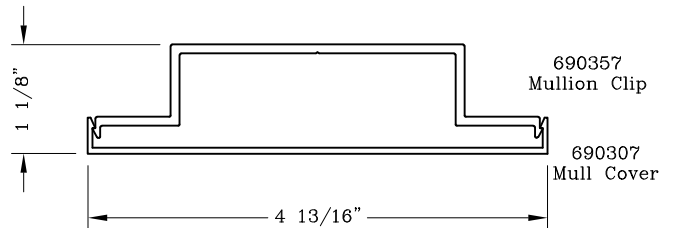
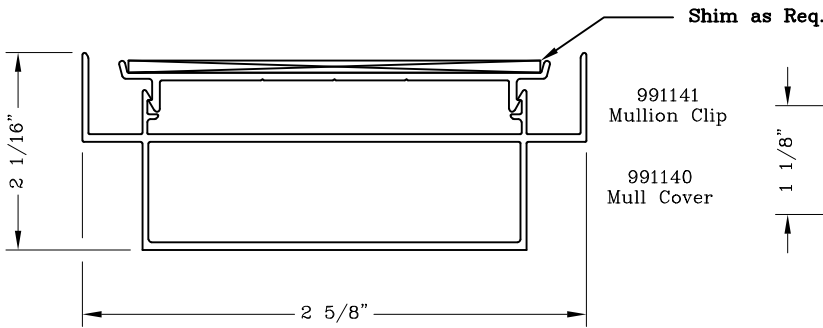
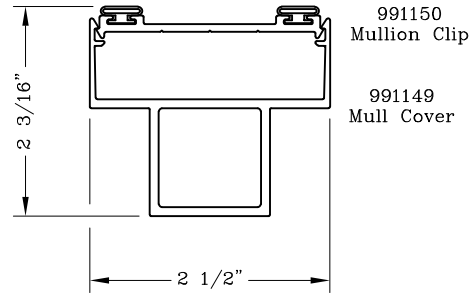
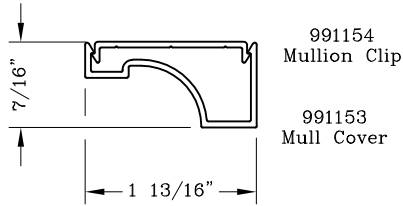

Mullcovers



Series: Accessories Manufacturing Code: MC06

Drawing 1/2 Scale – For Custom Size Drawing Contact Graham

Note: Sealant Not Shown On Details. Refer To General Installation Instructions.

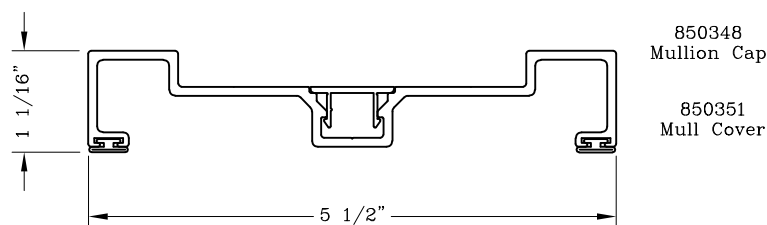
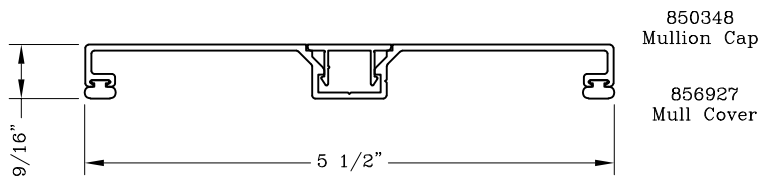
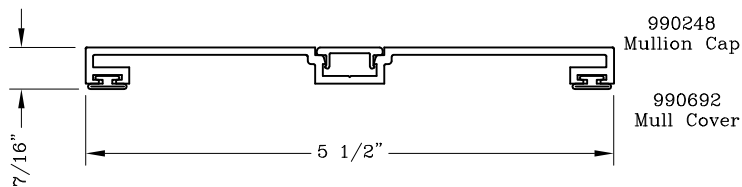
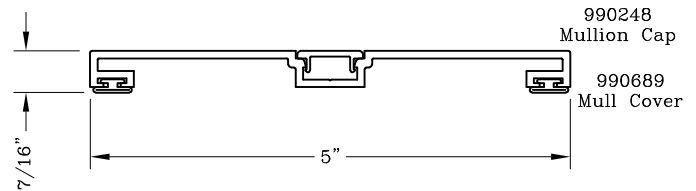
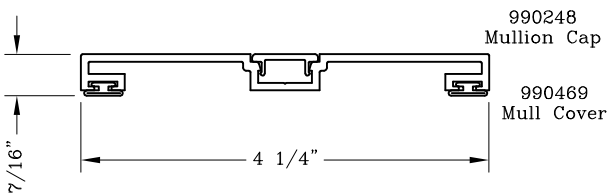
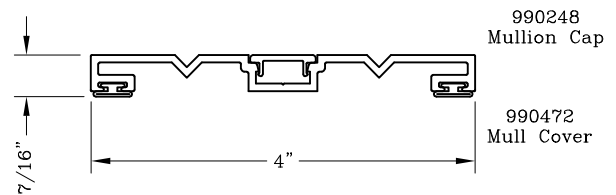
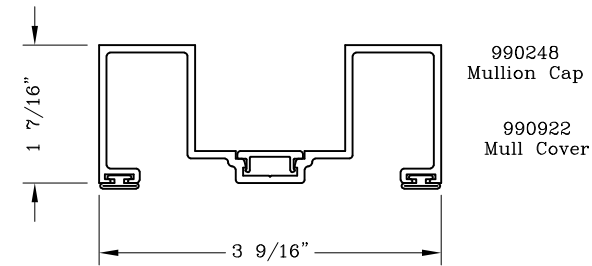
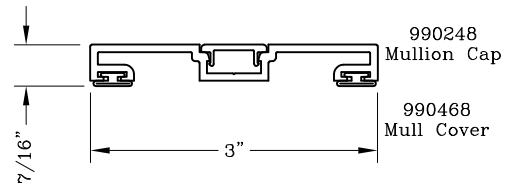
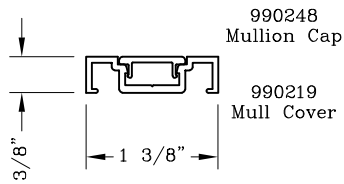

Graham Architectural Products reserves the right to change, add, cancel, remove or otherwise modify the details illustrated without prior notice.

1551 Mt. Rose Avenue, York, Pennsylvania 17403-2909 717.849.8100 Toll Free: 800/755-6274

Web Site: www.grahamwindows.com

0223 – MC.06

Mullcovers



Series: Accessories Manufacturing Code: MC07

Drawing 1/2 Scale – For Custom Size Drawing Contact Graham

Note: Sealant Not Shown On Details. Refer To General Installation Instructions.

